

500
2019

Bulletin

of the International Dairy Federation

Wastewater Treatment in Dairy Processing

Innovative solutions for sustainable
wastewater management



Bulletin of the International Dairy Federation 500/2019

© 2019, International Dairy Federation

GENERAL TERMS AND CONDITIONS FOR USING THIS ELECTRONIC PUBLICATION

INTRODUCTION

Use of the material provided in this publication is subject to the Terms and Conditions in this document. These Terms and Conditions are designed to make it clear to users of this material what they may and may not do with the content provided to them. Our aim has been to make the Terms and Conditions unambiguous and fair to all parties, but if further explanation is required, please send an e-mail to info@fil-idf.org with your question.

PERMITTED USE

The User may make unlimited use of the Content, including searching, displaying, viewing on-screen and printing for the purposes of research, teaching or private study but not for commercial use.

COPYRIGHT

Site layout, design, images, programs, text and other information (collectively, the "Content") is the property of the International Dairy Federation and is protected by copyright and other intellectual property laws. Users may not copy, display, distribute, modify, publish, reproduce, store, transmit, create derivative works from, or sell or license all or any part of the content obtained from this publication. Copyright notices must not be modified or removed from any Content obtained under the terms of this licence.

Any questions about whether a particular use is authorized and any requests for permission to publish, reproduce, distribute, display or make derivative works from any Content should be directed to info@fil-idf.org

AVAILABILITY

Although the International Dairy Federation publications are developed in view of maximum user-friendliness, the International Dairy Federation cannot guarantee any of these products to work on or with any particular computer system.

LIABILITY

Although the International Dairy Federation has taken reasonable care to ensure that the information, data and other material made available in its publication is error-free and up-to-date, it accepts no responsibility for corruption to the information, data and other material thereafter, including but not limited to any defects caused by the transmission or processing of the information, data and other material. The information made available in this publication, has been obtained from or is based upon sources believed by the International Dairy Federation to be reliable but is not guaranteed as to accuracy or completeness. The information is supplied without obligation and on the understanding that any person who acts upon it or otherwise changes his/her position in reliance thereon does so entirely at his/her own risk.

Send any comments or inquiries to:

International Dairy Federation (I.N.P.A.)

Boulevard Auguste Reyers 70/B

1030 Brussels

Belgium

Phone: + 32 2 325 67 40

Fax: + 32 2 325 67 41

E-mail: info@fil-idf.org

Web: www.fil-idf.org



Wastewater Treatment in Dairy Processing

Innovative solutions for sustainable
wastewater management

Piercristiano Brazzale, Brice Bourbon, Pierre Barrucand, Mark Fenelon,
Stefano Guercini and Raffaele Tiarca

WASTEWATER TREATMENT IN DAIRY PROCESSING

INNOVATIVE SOLUTIONS FOR SUSTAINABLE WASTEWATER MANAGEMENT

Piercristiano Brazzale (IT), Brice Bourbon (FR), Pierre Barrucand (FR), Mark Fenelon (IE), Stefano Guercini (IT) and Raffaele Tiarca (IT).

ABSTRACT

Like all wastes produced by a production plant, dairy wastewater needs to be treated before it is discharged into water bodies. Owing to their composition and organic matter content, biological treatments are emphasised and, currently, activated sludge is one of the most used processes. This treatment, completed by other unitary operations, achieves the quality levels required for the discharge. However, dairy wastewater has interesting potentialities. Its unique composition can support energy production and its treatment, under some conditions, can allow the recovery of water for its reuse. Different technologies are currently available to accomplish these objectives: anaerobic reactor to treat carbon pollution and producing biogas, membrane bioreactor and membrane filtration for treating and producing water for reuse. Some dairy plants already use these technologies and their feedbacks are positives.

Keywords: *wastewater treatment, dairy industry, anaerobic reactor, membrane bioreactor, membrane filtration, water reuse, biogas production.*

67 pp - English only

Bulletin of IDF N° 500/2019 – 35 EUR – Date: 2019

WASTEWATER TREATMENT IN DAIRY PROCESSING

INNOVATIVE SOLUTIONS FOR SUSTAINABLE WASTEWATER MANAGEMENT

TABLE OF CONTENTS

Foreword	1
Acknowledgements	1
Glossary	3
1 Introduction	5
2 Wastewater treatment in Dairy Processing	7
2.1 Dairy wastewater generation and characteristics	7
2.2 Dairy wastewater treatment	8
2.2.1 Primary treatments	9
2.2.2 Secondary treatments	10
Aerobic solutions	10
Anaerobic solutions	11
2.2.3 Tertiary treatments	12
3 Innovative wastewater treatments.	15
3.1 Introduction	15
3.2 Anaerobic reactor	16
3.2.1 Principle	16
3.2.2 Efficiency.	17
3.2.3 Importance as an eco-friendly and innovative technology	18
3.3 Membrane bioreactor	18
3.3.1 Principle	19
3.3.2 Efficiency.	20
3.3.3 Other characteristics	21
3.3.4 Importance as an eco-friendly and innovative technology	21
3.4 Membrane filtration (MF, UF, NF, OI).	21
3.4.1 Principle	21
3.4.2 Efficiency.	23
3.4.3 Importance as an eco-friendly and innovative technology	24
4 Case studies.	25
5 Conclusions	63
6 References	65

Subscription price for the electronic version of the 2019 Bulletin : 600 Euro for all issues.

Place your order at : INTERNATIONAL DAIRY FEDERATION / FEDERATION INTERNATIONALE DU LAIT.

Boulevard Auguste Reyers, 70/B - 1030 Brussels (Belgium)

Telephone : +32 2 325 67 40 - Telefax : +32 2 325 67 41 - E-mail : info@fil-idf.org - <http://www.fil-idf.org>

FOREWORD

Responsible use of water in the food system is an objective shared by many. The actors of the dairy sector are committed to adopting sustainable practices throughout the value chain. The International Dairy Federation's (IDF) role is to share knowledge and expertise to the entire dairy supply chain, including wastewater processing and treatment options. The IDF is proud to launch this publication, entitled 'Wastewater Treatment in Dairy Processing'. The publication provides an overview of eco-friendly and innovative wastewater treatment technologies available to the dairy processing sector. It offers solutions to drive sustainability and continuous improvement of the environmental impact of the dairy sector.

IDF wishes to thank all contributors and the IDF team whose hard work and commitment has brought this publication to life.

Caroline Emond
Director General
International Dairy Federation

ACKNOWLEDGEMENTS

This document was developed thanks to the invaluable contributions of members of the International Dairy Federation (IDF) Action Team on Innovative Practices for Eco-friendly Dairy Technologies. Under the overall guidance of the Action Team leader, Piercristiano Brazzale (IT), this Bulletin was prepared by Brice Bourbon (FR), Pierre Barrucand (FR) with contributions from Mark Fenelon (IE), Stefano Guercini (IT) and Raffaele Tiarca (IT). Their active input made the production of this document possible.

Brice Bourbon (FR) contributed to the coordination of the case studies showcased on this IDF Bulletin and provided technical editorial support. The case studies were provided by IDF members from Canada, France, Germany, Ireland, Italy, Japan, Sweden and India.

Valuable comments and input on the Bulletin were provided by Martin Scuccimarri (CA), Craig Holden (CA), Mark Fenelon (IE), S.M. Ashekuzzaman (IE), Owen Fenton (IE), Mia Lafontaine (NL), Janusz Turowsky (PL), Peter De Jong (NL), Yves Pouliot (CA), Rainer Bertsch (DE), Geoffrey Smithers (US) and Thomas H. Weißer (DE). We would also like to honour the memory of Phil Clarke (AU), who was a cherished and active member of this Action Team.

Valuable comments and final approval of the report were provided by the Standing Committee Chairs, Deputy Chairs and members of the Standing Committees on Environment and Dairy Science and Technology.

Finally, many thanks as well to Dr María Sánchez Mainar from the IDF Head Office for her active contribution to this document and the overall coordination of the work.

GLOSSARY

BOD: Biological Oxygen Demand (BOD₅: Biological Oxygen Demand in five days)

COD: Chemical Oxygen Demand

CSTR: Continuous Stirred Tank Reactor

DO: Dissolved Oxygen

EGSB: Expanded Granular Sludge Bed

FAU: Formazin Attenuation Unit

FO: Forward Osmosis

HRT: Hydraulic Retention Time

MBBR: Moving Bed Biofilm Reactor

MBR: Membrane BioReactor

MF: MicroFiltration

MLSS: Mixed Liquor Suspended Solids

NF: NanoFiltration

RO: Reverse Osmosis

SBR: Sequencing Batch Reactor

SRT: Solid Retention Time

TDS: Total Dissolved Solids

TKN: Total Kjeldahl Nitrogen

TN: Total Nitrogen

TP: Total Phosphorus

TSS: Total Suspended Solids (the abbreviation SS can also be used)

UASB: Upflow Anaerobic Sludge Blanket

UF: UltraFiltration

VM: Volatile Matter

1

INTRODUCTION

This document has been written for use by the dairy processing sector. It constitutes a guide that professionals can consult to improve the treatment and valorisation of wastewater produced on site or to identify a state-of-the-art technology in the event that a treatment plant requires replacement.

The issue is composed of three main parts. The first chapter focuses on dairy wastewater characteristics (origin, composition, volume) and the processes which can be used to treat them before discharge. The second chapter highlights several innovative technologies that could be implemented on sites to treat and enhance effluents. A focus is made on one primary treatment using CO₂ for the pH neutralisation, two secondary treatments (anaerobic reactor and membrane reactor), allowing respectively the generation of energy from effluents and the production of high-quality water, and membrane processes that could be used as tertiary treatments (microfiltration, ultrafiltration, nanofiltration and reverse osmosis). The third and final chapter gathers case studies from different dairy plants which use these innovative technologies. Technical data and feedback from processors are compiled in these sheets.

2

WASTEWATER TREATMENT IN DAIRY PROCESSING

2.1. Dairy wastewater generation and characteristics

The generation of dairy wastewater, in terms of volumes and composition, is related to the type of production, processes and practices used in the dairy processing plants. As well as the need or opportunity to recover the water resource.

In a dairy plant, wastewaters essentially originate from processing, cleaning and sanitary operations such as cleaning-in-place (CIP), cleaning of process equipment, floors, rooms and also trucks. Thus, this term refers to all outgoing waters of the plant, except rainwater (also routinely referred to as storm water).

Table 1 reports typical wastewater discharge (m^3/tonne of processed raw material) observed in Europe for four dairy product manufacturing categories.

Table 1: Wastewater discharge flows in European dairies [1]

Product	Wastewater discharge flow (m^3/tonne of processed raw material)
<i>Drinking milk</i>	0.20 - 7.80
<i>Cheese</i>	0.75 - 3.25
<i>Powder</i>	1.00 - 3.25
<i>Fermented milk</i>	2.00 - 11.1

Wastewaters from dairy industries contain both organic and inorganic compounds: milk and by-products residues in the case of the former, while the latter is influenced by the use of sanitizers, alkaline and acidic products in the latter [2].

Extensive variations in the concentration of different compounds and effluent loading markers in dairy wastewaters discharged to treatment plants is evident according to Table 2.

Table 2: Ranges of values for different parameters measured on wastewater

BOD ₅ (g/L)	COD (g/L)	TSS (g/L)	TN (g/L)	TP (g/L)	pH	Reference
0.24 - 5.9	0.5 - 10.4	0.06 - 5.80	0.01 - 0.66	0 - 0.06	4 - 11	[3]
0.5 - 3.0	0.72 - 5.29	0.16 - 1.00	0.03 - 0.70 (TKN)	0.02 - 0.34	3 - 13	[4]
1.08 - 1.58	1.98 - 3.32	2.40 - 2.95	0.08 - 0.09 (TKN)	0.06 - 0.08	5.9 - 6.5	[5]

Chemical Oxygen Demand (COD) concentrations are determined by the presence of milk, sugars (e.g. lactose) and added sugars, cream or whey in the wastewater. A BOD₅/COD ratio within the range 0.4 - 0.8 indicates a relatively good biodegradability of wastewater. For instance, in the case of whey, the highest COD and BOD₅ concentrations are usually between 60-80 g.L⁻¹ and 30-50 g.L⁻¹, respectively, with lactose being responsible for 90% of the COD and BOD₅ contribution [3].

The presence of nitrogen originates largely from milk proteins or ionic species such as NH₄⁺, NO₂⁻ and NO₃⁻. Phosphorus compounds in effluents have two origins: they come from the raw matter and from the alkaline and acidic cleaning products used in plants which contain phosphates [2].

2.2. Dairy wastewater treatment

The treatment of a dairy wastewater takes place in three successive steps configured to achieve the following objectives (Table 3):

- Primary treatment: the purpose is to prepare the reflux to the next stage. This is achieved, by the removal of components which could prevent the successful functioning of the next treatments. In this phase, screening, pH neutralization, sedimentation and flotation are included.
- Secondary treatment: this stage consists in removing carbon and nitrogen compounds and, to a lesser extent, phosphorus substances. Thanks to the high biodegradability of the effluents, it is performed by technologies based on biological process.
- Tertiary treatment: according to water discharge characteristics, this step may include chemical or biological removal of phosphorus and excess of suspended solids, etc.

Their choice and sequence depend on factors such as the characteristics of the waste, the quantity produced and the rate of production (weekly, seasonal fluctuations), the environmental and health constraints imposed by the local regulations, the possibility and convenience to recover matter (water) and energy.

In particular, fluctuations in flow rates are related to the typical discontinuity in the production cycles of the different products; a characteristic that influences the choice of

the wastewater treatment option, as specific biological systems have difficulties dealing with wastewater of varying organic loads.

Table 3: Dairy wastewater treatments implemented on site

Primary	Secondary	Tertiary
Screening	Activated sludge	Nitrification/denitrification
Buffer tank	Membrane bioreactor (MBR)	Nitration/Annamox
pH neutralization	Anaerobic reactor (UASB, EGSB, CSTR)	Phosphorus removal (chemical or biological)
Sedimentation/Flotation		Membrane filtration
Moving Bed Biofilm Reactor (MBBR)	Sequential Batch Reactor (SBR)	Disinfection (if water reuse is expected)
Coagulation-flocculation	Aerated lagoons	Constructed wetlands

2.2.1. Primary treatments

Primary treatment mainly consists of removing unwanted components which could disturb the successful functioning of the treatment plants (e.g. coarse waste, sand). On a dairy plant, we can find in this order: screening, buffer tank coupled with pH neutralization, sedimentation and/or flotation.

Screening is an operation involving the removal of coarse waste with the help of gratings and screens.

Buffer tanks are applied in order to mitigate flow variations at the inlet of the treatment plant and to distribute a continuous volume of wastewater to the downstream treatments. It is in this tank that pH neutralization can occur due to the successive inlets of acid and alkaline wastewater. Sometimes, it is necessary to add a chemical product to reach a pH value suitable for the good running of the secondary treatment. However, one solution currently employed on some plants to avoid this addition of chemical products is pH neutralization by means of CO₂ injection. The purpose of this process is to transform CO₂ to carbonic acid and inject it in the effluent to decrease pH. This treatment is used for alkaline wastewater (see case study 1).

Finally, sedimentation is an operation during which elements with high density drop to the bottom of a tank whereas flotation consists in bringing to the surface pollutants with low density thanks to air bubbles in order to remove them.

Other primary treatments can be also used on dairy plants: moving bed biofilm reactor (MBBR) and coagulation-flocculation.

A moving bed biofilm reactor is a technology consisting of an activated sludge tank, containing plastic mounts on which active biomass can grow. Its use as a primary treatment

enables the removal of an important part of the carbon load. It also commences the treatment of nitrogen compounds.

Coagulation-flocculation consists in aggregating some suspended solids non settleable in denser particles. Then, a sedimentation step of the new particles is realized.

2.2.2. Secondary treatments

Secondary treatments based on biological phenomena may include both aerobic and anaerobic solutions.

Aerobic and anaerobic: what does it mean?

- An environment is said to be aerobic when there is presence of free oxygen.
- An environment is said to be anaerobic when there is the absence of free and combined oxygen (combined oxygen is oxygen associated with other elements like nitrogen to form nitrates).

Aerobic solutions

Activated sludge is the most frequently observed aerobic solution in dairy plants (Figure 1). This solution can ensure compliance with the maximum carbon and nitrogen discharge limits, even when working with highly diluted wastewater and at relatively low temperatures.

An activated sludge process is composed of two units: the aeration tank and the clarifier. In the first, effluents are mixed with an active biomass capable of degrading the carbon and nitrogen pollution in the presence of oxygen. In the second, the solid phase (biological flocs) and the aqueous phase (treated water) are separated. The flocs are extracted from the bottom of the clarifier and the treated water is discharged.

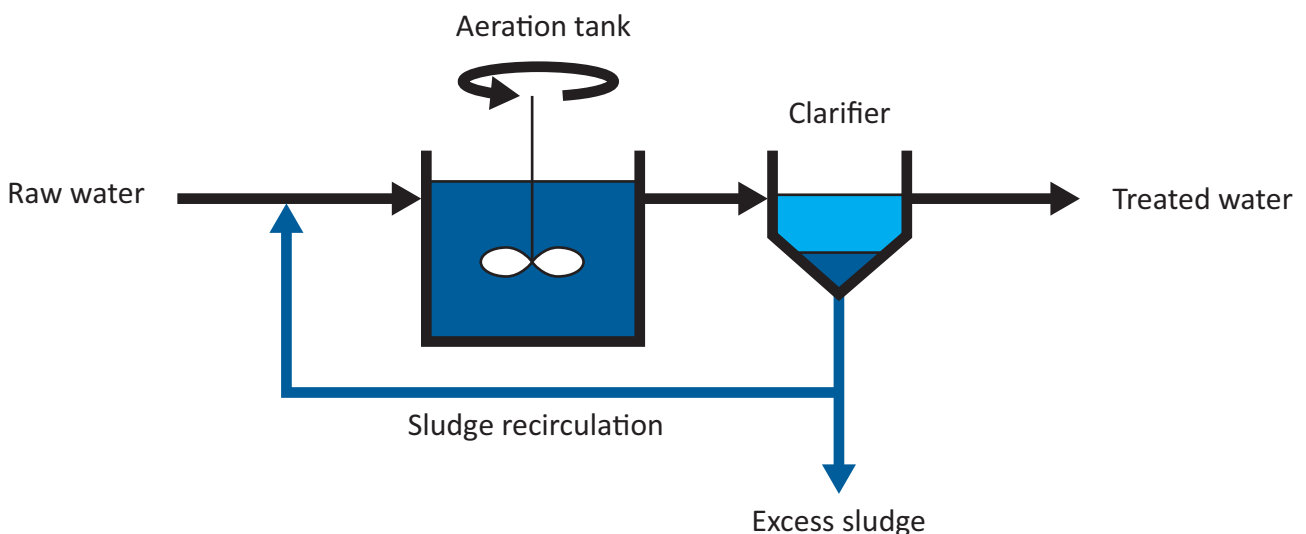

Figure 1: Simplified diagram of an activated sludge
(Reference: Suez Water Handbook)

In dairy plants, activated sludge processes used are of two types: activated sludge with extended aeration and low-loaded activated sludge. Some functioning parameters of these processes are resumed in the table 4

Both technologies facilitate a higher carbon load removal and a good nitrogen removal.

Table 4: Characteristics of two types of activated sludge (extended aeration; low-loaded)

Parameters	Unity	Extended aeration	Low-loaded
Mass loading	kgBOD ₅ .kgVM ⁻¹ .J ⁻¹	<0.07	0.07 < x < 0.15
MLSS	kg.m ⁻³	3 - 5	3 - 5
HRT	hours or days	5 days	12 hours
SRT	days	20	10
O ₂ needs	kgO ₂ .kgBOD ₅ ⁻¹	2	1.3 < x < 1.5
BOD ₅ removal	%	93-97	93-97
Nitrogen removal	%	90-40	90-40
Phosphorus removal	%	30	30

Other solutions based on the use of suspended sludge exist. These include sequencing batch reactor (SBR) or membrane bioreactor (MBR). The principle of the SBR is the same as that of activated sludge with one exception: there is only one tank for the aeration and the clarification. The two operations are performed thanks to sequential treatment breakdowns. Thus, this treatment requires less surface area. Regarding the membrane bioreactor, its functioning is also similar to an activated sludge. However, the clarification is made with membrane filtration. This technology will be described in detail in the next chapter.

Some dairies use also aerated lagoons to treat their wastewater. Lagoons are great basins in which wastewater arrives in order to be treated under the action of the wind and the sun which promote the development of an active biomass enabling to degrade, in particular, carbon pollution. A mechanical aeration can be applied in order to increase the biological process and, consequently, the treatment.

Anaerobic solutions

Anaerobic technology is interesting when wastewaters have a high concentration of organic matter. Thus, some anaerobic reactors can be used for the treatment of overloaded effluents with COD concentration higher than 15 g/L. COD reduction with this technology is about 70 – 80% considering typical dairy effluent. Several studies have also shown that the average COD reduction with this technology is about 90% especially when dairy wastewaters have been degreased beforehand [3; 6]. Some anaerobic reactors specially applied to treat whey can allow obtaining COD reduction about 95%.

However, in contrast to aerobic solutions, nitrogen and phosphorus removal is low as confirmed by ratio of COD/N/P removal: 800/5/1. Regarding anaerobic reactors treating

where, phosphorus removal is better due to precipitation of struvite and calcium phosphate. Consequently, to ensure the more complete removal of the different pollutions contained in the wastewaters, some dairy plants combine anaerobic and aerobic treatment.

The main advantage of anaerobic technology is biogas production which occurs during the degradation of the carbon pollutant in the reactor. The product can then be used as a new energy source for the production plant. Moreover, this technology carries out lower sludge production.

Anaerobic technology and one process example will be highlighted in the next chapter.

A comparison between aerobic and anaerobic technologies is presented in table 5.

Table 5: Comparison between aerobic and anaerobic technologies

Parameter	Aerobic	Anaerobic
Energy requirement	High	Low
Energy production	None	Good (average methane production: 60 to 75%)
COD loading rate	Low / Medium	Medium / High (average COD loading rate: 5-10 kgCOD.m ⁻³)
COD reduction	95% - 99%	70% - 90%
Nutrient removal (N, P)	Good	Low
Bacteria growth	Fast	Slow (10 folds less)
Sludge production	High (about 40%)	Low (about 8%)
Load variation	Accepted	Not Accepted but COD reduction is lower during few days after the load variation
Temperature sensitivity	Relatively low	Medium
Inhibitory action of the fat	No	Yes
Alkalinity addition needed	No	Yes
Area consumption / footprint	High (except for some technologies like MBR and SBR)	Low
Investment cost (CAPEX)	Low	High
Maintenance	High	Low

2.2.3. Tertiary treatments

In general, tertiary treatments are applied to remove a particular residual pollutant after the biological step. In the dairy sector, nitrification/denitrification and biological or chemical phosphorus removal are the tertiary treatments most frequently encountered.

Nitrification and denitrification are necessary steps to remove nitrogen pollution. Nitrification consists in transforming ammonium in nitrates in the presence of oxygen

and nitrifying bacteria. Denitrification consists in converting nitrates in gaseous nitrogen. This step is performed in an environment containing denitrifying bacteria and without dissolved oxygen. Another process exists to treat the nitrogen pollution: the Anammox reaction. This permits to turn ammonium into gaseous nitrogen without passing by the step of nitrification. Thus, the oxygenation of the environment is not necessary, which implies a cost reduction.

Regarding the phosphorus removal, two ways can be considered: biological and chemical. The biological way consists in submitting bacteria to a succession of anaerobic and aerobic periods. This stress causes the storage of an important quantity of phosphates inside these cells which are then removed with the excess sludge. In contrast the chemical way involves adding solutions with metallic salts like ferric chloride to form a precipitate with phosphorus. This precipitate is then removed by sedimentation.

Other techniques can be used to produce a water of high quality for discharge in water bodies or reuse.

Some dairy plants use constructed wetlands to polish the treatment of wastewaters. This technique is also applied as a secondary treatment but for large production plants, however, its efficiency proves to be limited.

In 2008, Dabrowski *et al.* carried out a study on this type of installation [7]. Two constructed wetlands were implemented following two steps of treatment (de-phosphating and transition in a low-loaded activated sludge chamber) to purify dairy wastewater. The first constructed wetland was a vertical-flow construction whereas the second was a horizontal-flow construction. The vertical flow constructed wetland is efficient at reducing carbon load and turning ammonium into nitrates. The horizontal flow constructed wetland allows reduction of residual carbon pollution and facilitates denitrification. This treatment has no effects on phosphorus removal. Results of the experiment were the following: the removal of COD and NH₄-N by the installation reached 85.3% and 91%, respectively. However, this technique requires extensive surface area in order to achieve efficient treatment.

Other technologies can be applied depending on the residual pollutants to be removed. This is the case of the membrane technologies which allow retention of some suspended solids and can contribute to the disinfection of the wastewaters. These technologies will be detailed in the next chapter.

3

INNOVATIVE WASTEWATER TREATMENTS

3.1. Introduction

The main goal of wastewater management is to treat effluents from dairy processes in order to reduce their organic load before they are discharged into water bodies or public sewage systems. However, this wastewater also represents an alternative resource. In this context, different technologies have been developed over several years to allow water discharges of better quality, reuse of treated wastewater or calorific valorisation.

Among these technologies, we can identify separation processes like membranes, membrane bioreactors or anaerobic reactors. These technologies emerged to be the most relevant based on a survey carried out among dairy processors.

This survey contained four questions among them one multiple-choice question on recent and strong technologies to study: membrane bioreactor, membrane filtration (microfiltration, ultrafiltration, nanofiltration), reverse osmosis, anaerobic reactor and disinfection technologies (UV and/or ozone). Results demonstrated that dairy processors were interested in: (1) anaerobic reactor, (2) membrane filtration, (3) reverse osmosis, (4) membrane bioreactor and (5) disinfection technologies (figure 2). Some dairy processors also proposed to study other treatments like flotation, SBR, activated sludge or sedimentation (treatments gathered in the category *Other technologies* in the figure). Therefore, a selection was performed, and these are the first four processes quoted which will be described in the rest of the document.

Technologies selected by the dairy processors

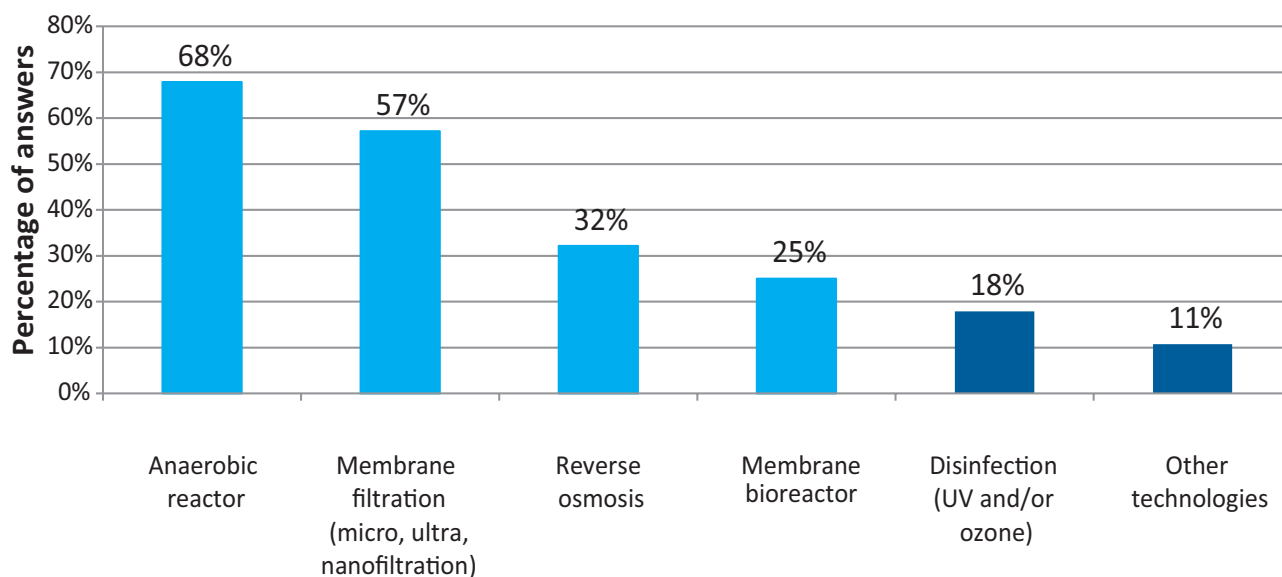

Figure 2: Results of the IDF survey (the technologies which are described in the publication are highlighted by the green bars)

3.2. Anaerobic reactor

Anaerobic reactor is a process which has multiple uses: it allows elimination of the major part of the carbon load contained in wastewaters by generating biogas, a mix of carbon dioxide (CO₂) and methane (CH₄). Additionally, the correspondingly lower sludge disposal costs favour the anaerobic systems. Several types of anaerobic treatments exist: up flow anaerobic sludge blanket (UASB), anaerobic filter, continuous stirred tank reactor (CSTR), expanded granular sludge bed (EGSB), etc. In dairy production plants, UASB is the more commonly used anaerobic technology.

3.2.1. Principle

In the UASB reactor, wastewater is distributed at the bottom of the reactor and is brought into contact with a granular blanket. This blanket is composed of suspended solids and micro-organisms responsible of the treatment. The wastewater treatment has two results: less sludge production and positive biogas production [8]. Produced biogas and treated effluent are recovered at the top of the tank (figure 3).

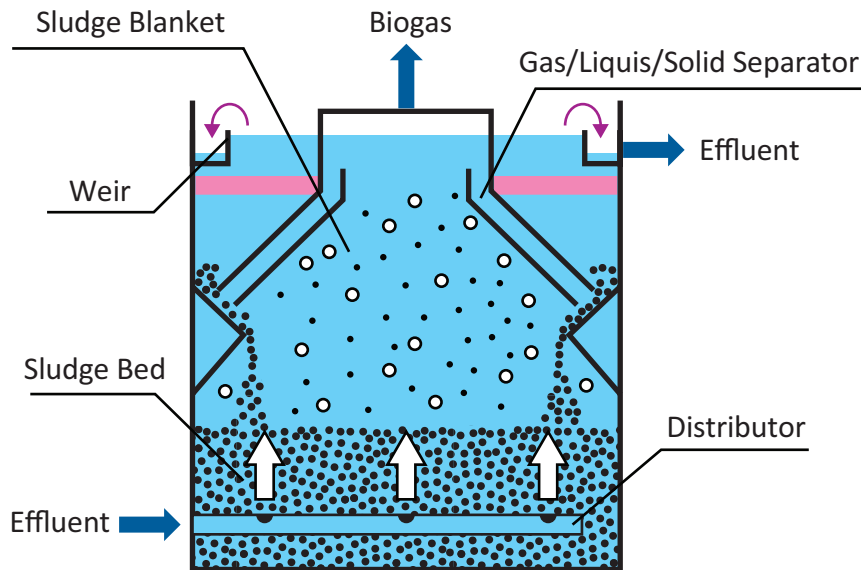

Figure 3: Diagram of an UASB reactor
(Reference: Industrial Technology Research Institute)

In order to ensure good progression of the anaerobic digestion, different factors have to be monitored with attention.

Firstly, it is recommended to maintain a pH between 6.5 and 8.5 (optimum: 7-8). A pH value below 7 leads to better environmental conditions for the acidogenic bacteria but not for methanogenic bacteria. As a consequence, methane production is reduced [9]. If the pH value is too high, these acidogenic bacteria are inhibited, and biogas production is stopped.

Secondly, temperature must be maintained at around 30 and 55°C [9]. It is possible to apply a lower temperature like 25°C but it causes a lower COD removal. In general, too high and too low temperatures are detrimental to biomass.

Finally, it is important to respect an appropriate hydraulic retention time (HRT). In UASB reactors, it could be about twelve to fourteen hours.

3.2.2. Efficiency

The efficiency of this treatment process can vary according to the composition of dairy wastewater.

Several studies based on different types on dairy wastewater show that the average COD removal efficiency of this treatment is 90%. This value is reached when a pre-treatment dedicated to the removal of fats and grease is performed. If wastewater contains these compounds, COD removal can be low (about 50%) and treated wastewater can present a high level of volatile suspended solids and a high turbidity [2].

Nitrogen and phosphorus removal are low using this technology. Thus, this technology is combined with an aerobic solution on industrial plants which have overloaded effluents. Thus, anaerobic solution can be considered as a pre-treatment permitting to remove a great part of the carbon pollution whereas aerobic solution is used to eliminate the residual carbon pollution and nitrogen and phosphorus compounds.

With regards to biogas production, anaerobic technologies allow a biogas generation of about $0.35 \text{ m}^3/\text{kg COD}_{\text{removed}}$ [2]. The biogas is usually composed of 60-65% of methane (CH_4), 35-45% of carbon dioxide and 0-5% of nitrogen [9].

Anaerobic wastewater treatment may be considered for dairies when COD concentration in wastewater is higher than 6.000 mg/L as it entails some operational expenses.

3.2.3. Importance as an eco-friendly and innovative technology

Anaerobic reactors are interesting for the dairy sector on two points:

- they are suitable for the treatment of overloaded effluents from the dairy plants. Indeed, wastewaters from dairy plants have not negligible COD concentrations and, in some cases, whey that is not recovered and processed into valuable products, is mixed with these wastewaters.
- their exploitation permits biogas production. This biogas can be used by the production plant not only for heating purposes, but also for the production of electricity.

Quantitative example:

A dairy plant receives each day 1600 m³ of milk. It releases 4000 m³ of wastewater with a COD concentration of up to 2.5 g/L. This represents a loss in COD of 10 tons per day. With an anaerobic technology, the dairy processor can generate 3500 m³ of biogas (equivalent to 2000 litres of fuel).

Several cases studies regarding the application of this treatment technology on dairy plants are compiled in the next chapter of the document.

3.3. Membrane bioreactor

Several research reports have demonstrated that a membrane bioreactor process was very effective over the conventional biological wastewater treatment process (e.g. activated sludge system) in terms of higher biodegradation efficiency, smaller footprint, less sludge production, complete removal of suspended solids and high quality treated effluents for re-use [10; 11]. Already applied for the treatment of urban wastewater, this technology also seems interesting for the treatment of dairy wastewater.

3.3.1. Principle

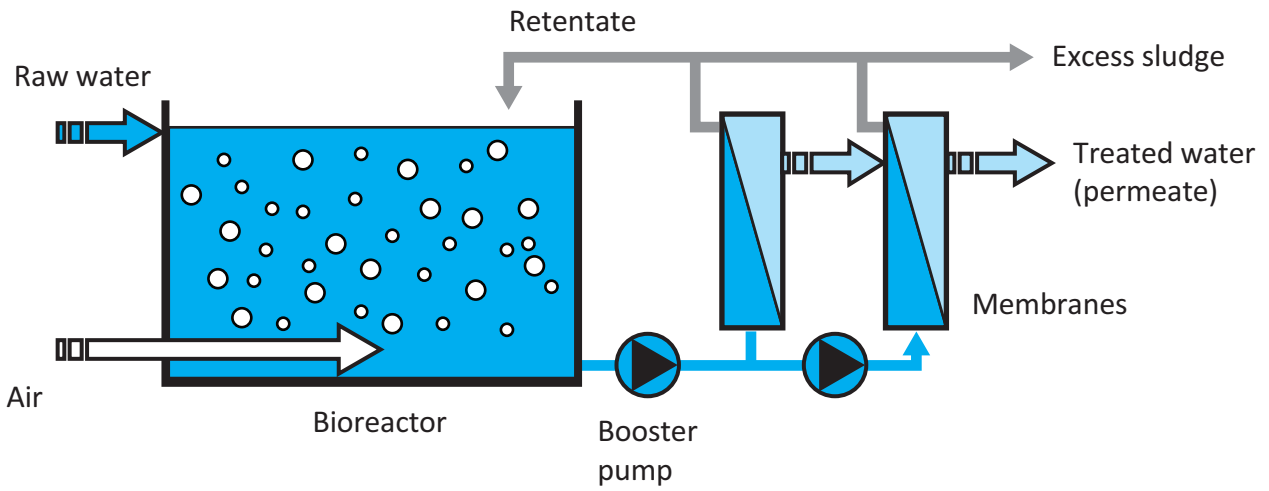

Figure 4: External Membrane Bioreactor
(Reference: Suez Water Handbook)

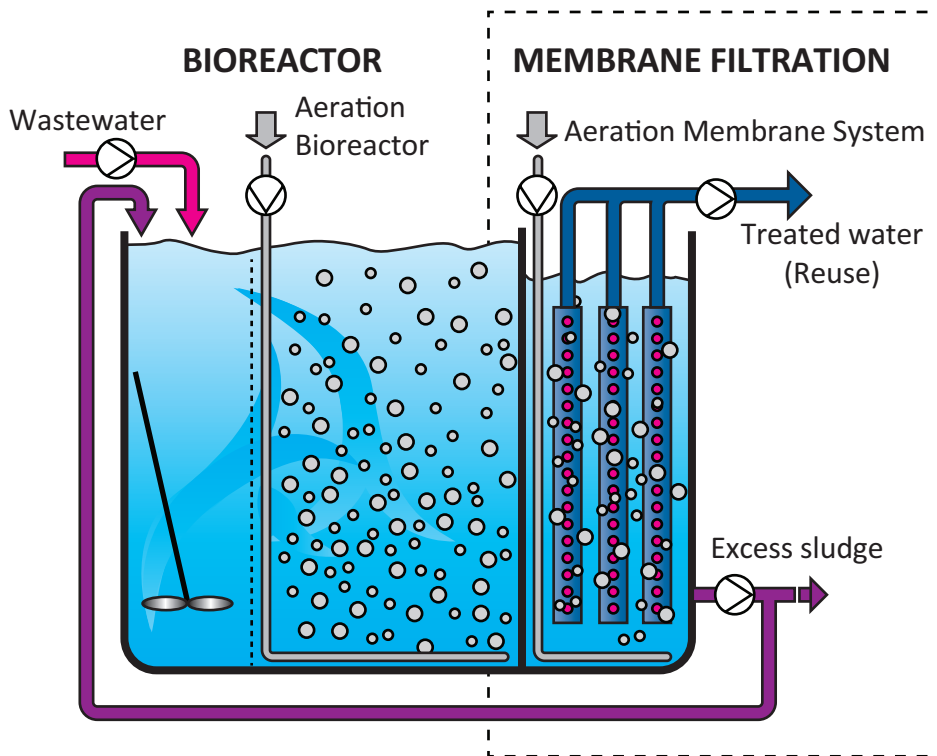

Figure 5: Submerged Membrane Bioreactor
(Reference: Lenntech)

A membrane bioreactor is a process which associates two types of treatment: a biological treatment and a membrane separation commonly using either micro or ultrafiltration. Two types of membrane bioreactor exist: membrane bioreactors with an external loop (figure 4) and submerged membrane bioreactors (figure 5). Membrane bioreactors with an external loop were the first to be developed but the energy costs associated with the sludge flow between the aerobic tank and the membrane were too high. Consequently, a new generation of membrane bioreactors was developed: the submerged membrane bioreactors.

On entry into the tank, wastewater is treated by the microbial flora associated with an activated sludge process. The mixed liquor is filtered with microfiltration or ultrafiltration membranes. The filtration is outer-inner, and treated water is recovered from the internal membranes. Excess produced sludge is removed at the bottom of the tank. "Sweeping" speed near membranes avoids their fouling. Air bubbles can be also injected in the filtration module to clean the exterior of these.

3.3.2. Efficiency

Recently, an MBR-based process has been investigated in order to evaluate performance during treatment of dairy wastewater to a high quality treated effluent standard and for subsequent reuse within the dairy industry. Dairy wastewaters from low to high load streams were treated to assess the suitability of MBR as secondary and tertiary wastewater treatment solution for dairy industry. Submerged MBRs with micro (usually hollow fibre membrane module of an average pore size of 0.4–0.5 μm) or ultrafiltration (membrane modules of an average pore size of 0.04 μm) were commonly used [10; 11; 12].

The average reported removal efficiencies on COD, BOD_5 , TN, $\text{NH}_3\text{-N}$ and TP were 94–99, 98–99.5, 86–93, 95–99.6, and 89–91%, respectively, based on their respective average feed concentrations in dairy wastewaters for COD = 385–6400, BOD_5 = 111–4400, TN = 50–115, $\text{NH}_3\text{-N}$ = 28–51, and TP = 8–36 mg.L^{-1} . In general, these removal efficiencies by the MBR technology adequately meet the standards of effluent quality (e.g. Uruguayan discharge standards (mg.L^{-1}) are BOD_5 = 60, TN = 10, $\text{NH}_3\text{-N}$ = 5, and TP = 5) that is safe to discharge to rivers [10].

In addition to meeting discharge standards for treated effluents, MBR treated effluents can also meet the standards of effluent quality for reuse as water for cooling, steam generation and washing external areas or floors and trucks. In this case, MBR treated effluents can be further treated by nanofiltration (NF) as tertiary treatment (mainly to reduce dissolved solids) for reuse purpose. Recent research has demonstrated that the investment for MBR as secondary treatment and NF as tertiary treatment for the reuse of dairy wastewater is a financially viable option for the dairy industry [13].

3.3.3. Other characteristics

The combination of biological treatment and clarification operations in the same tank enables a much higher mixed liquor suspended concentration solids (between 8 and 18 g.L⁻¹) in relation to the concentration observed in activated sludge systems (between 2 and 4 g.L⁻¹) to be obtained [14]. The improved treatment efficiency is also accompanied by a better capacity to address load variations. Moreover, this combination process requires a tank with a smaller surface area than that with a conventional activated sludge system. Sludge production is also minimised.

3.3.4. Importance as an eco-friendly and innovative technology

Capital and operational costs of a membrane bioreactor are high and in the dairy sector, problems can occur due to membrane fouling. Indeed, the energy consumption may be up to 6 kWh.m⁻³ of treated wastewater and the membrane lifetime is about 2-5 years due to the presence of calcium.

However, based on performance and advantages over conventional biological wastewater treatment processes, this technology addresses the requirements of stringent effluent quality discharge licenses and facilitates recovery of water for re-use purpose. As a consequence, it indirectly reduces freshwater use. Costs related to the use of chemicals, the water utility service and sludge disposal are also reduced.

Several cases studies regarding the application of this treatment technology on dairy plants are compiled in the next chapter of the document.

3.4. Membrane filtration (MF, UF, NF, RO)

Membrane filtration is commonly considered as the tertiary wastewater treatment process for polishing effluent quality to meet strict discharge standards or to reuse treated effluents for the purpose of substituting fresh water supply. Different types of membrane may be used: porous membranes (microfiltration, ultrafiltration and nanofiltration) and dense membranes (some nanofiltration processes and reverse osmosis).

3.4.1. Principle

Membrane filtration relies on the retention by a membrane of compounds contained in water. Removed elements constitute the retentate whereas filtered water constitutes the permeate. Different membranes may be considered according their selectivity (figure 6).

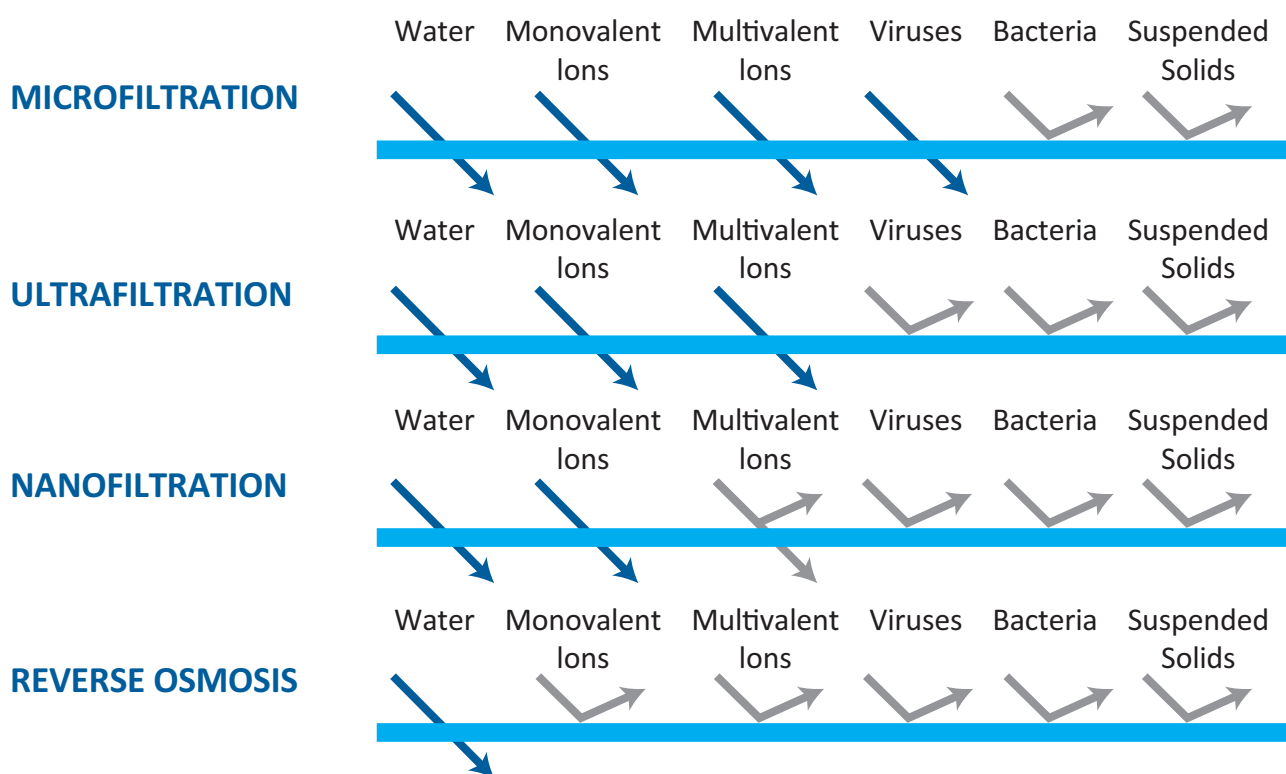

Figure 6: Pollutants retained by each type of membrane
(Reference: Pentair X-Flow)

Membrane filtration usually follows a biological wastewater treatment step similar to membrane bioreactors with an external loop, i.e. membrane filtration is externally configured with biologically pre-treated wastewaters. The most common approach in membrane separation processes consists of two filtration stages – firstly, microfiltration (MF) to separate solids at relatively low pressure (1–2 bar), and secondly, pressure driven nanofiltration (NF) or reverse osmosis (RO) or ultrafiltration (UF) to retain more specific solutes [15]. The question of integrating membrane filtration with biological processes needs to be justified on the basis of permeate quality and recovery volume, energy requirement, transmembrane pressure and permeate flux (i.e. filtration rate). Research on the integration of membrane filtration as a post-biological treatment process for treating dairy wastewater is still limited [15; 16].

Focus on reverse osmosis (RO) and forward osmosis (FO):

RO, like nanofiltration, is a high-pressure membrane process operating between 10–80 bar with a typical operating pressure of about 30 bar. In reverse osmosis, the applied pressure is used to overcome osmotic pressure, forcing water from the dairy stream and concentrating dissolved solutes and colloidal materials (total dry matter). Applications of RO in the dairy industry include cost effective primary total dry matter concentration of milk and whey streams (up to 30 % dry matter), as a precursor to final concentration in an evaporative step. Often RO is also applied as a pre-treatment for dilute dairy streams for logistical cost effectiveness. Other applications include white water recovery from flushing operations and streams such as evaporator condensate, salt recovery from brines

and nanofiltration permeates, and as the primary unit operation in a water recovery system both in primary recovery and polishing applications. Similar to nanofiltration loss of feed material components in permeate streams can be an issue when concentrating to high dry matters and/or when handling materials with a high osmotic potential.

FO is a non-pressure membrane separation technology that can be used to concentrate liquid systems in an energy efficient way compared to other membrane processes that require hydraulic pressure. The technology utilises low pressure and heating parameters, thus facilitating minimal thermal degradation of heat labile nutrients and reduced cost of maintenance and cleaning (i.e., reduced fouling) [17]. FO works by using a draw solution (osmotic agent) to 'pull' water from a feed stream across a semi-permeable membrane. Therefore, the inexpensive and non-toxic draw solution must have a higher osmotic pressure than the feed stream [18] and should control the performance of the FO system via optimisation of characteristics such as osmotic pressure, concentration, molecular weight, water solubility, and viscosity [19]. The membrane should have a high flux, low internal concentration polarisation, maximum mechanical strength and highly dense active layer to ensure maximum salt rejection [17]. Forward osmosis is currently been used in many applications including water treatment, e.g., desalination and wastewater treatment [20; 21; 22].

3.4.2. Efficiency

Recently, various combinations (e.g. MF, UF, MF+UF, MF+NF and MF+RO) of membrane filtration were investigated to assess performance during treatment of dairy wastewater (after mechanical or biological pre-treatment) to achieve high quality treated effluents (i.e. permeate). Pre-treated dairy wastewaters having COD = 2200–3500 mg.L⁻¹, TSS = 1860 mg.L⁻¹, TKN = 40–85 mg.L⁻¹, colour = 1200–1400 mg Pt-Co/L, and turbidity = 130–230 FAU were observed to be effectively treated by MF+UF and MF+RO strategy with COD removal efficiencies of up to 99%, TSS 100%, colour 98% and turbidity >99% by MF+UF, and removal of total organic carbon up to 84%, colour 100%, TKN 94% and turbidity 100% by MF+RO, respectively [15; 16]. It was observed that the MF+UF process is significantly a lower pressure combination (operated at 3 bar of transmembrane pressure) in comparison to MF+RO combination (20 bar).

The treated effluents after the membrane filtration process (particularly in combination with MF+UF and MF+RO) were observed to meet the quality required for reuse having COD < 75 mg per L⁻¹, TSS <0.5 mg per L⁻¹ and turbidity 0.2 NTU [16].

3.4.3. Importance as an eco-friendly and innovative technology

Where capital and operational costs are important and if the issue relating to retentates needs to be considered, membrane filtration seems interesting for two reasons:

- production of high-quality water for discharge to water bodies (this process can be performed to remove residual pollutants in situations where discharge limits are very stringent)
- production of high-quality water for reuse

Several case studies regarding the application of this treatment technology on dairy plants are compiled in the next chapter of the document.

4

CASE STUDIES

This part of the document is dedicated to the presentation of innovative wastewater treatments already implemented on dairy production plants.

The different case studies developed in this chapter are listed in the following table of contents.

Pre-treatment

Carbon dioxide for pH balancing (Canada) 29

Anaerobic reactor

Complex system of anaerobic fermentation and biomass boiler (Japan) 31

Biogas production in the dairy plant (Germany) 35

Synergy between anaerobic and aerobic treatments (Italy) 37

Biogas production in the dairy plant (Sweden) 41

Biogas production in the dairy plant (Ireland) 45

Use of anaerobic and aerobic reactors to treat dairy wastewater (India). 47

Membrane bioreactor

Membrane bioreactor for wastewater from ice cream plant (Japan) 49

Membrane bioreactor for wastewater from liquid diet plant (Japan). 53

Membrane bioreactor for wastewater from dairy plant (Japan) 57

Membrane filtration

Ultrafiltration at the outlet of lagoon plant (France) 61

Case study 1

CARBON DIOXIDE FOR PH BALANCING

A Canadian dairy company has implemented a treatment system on one of their facilities to neutralise process effluent within permitted pH limits. The system utilises eductors to promote mixing, an automated bypass for 'within specification' effluent that serves to increase retention times, along with CO₂ dosing to reduce high pH levels to meet regularity requirements.



Technical characteristics

- CO₂ is sparged into a secondary silo forming carbonic acid, which enables precise effluent neutralization.
- A bypass valve diverts effluent within permitted limits, eliminating the need for additional storage capacity.
- Eductors promote mixing, providing 10 times the benefit compared with the open pipe equivalent, while eliminating costs for electrically driven blowers.

Volume and composition of raw wastewater

- Composition: >75% process and cleaning water
- Average flow: 600,000 m³/year
- Typical influent wastewater pH: >10

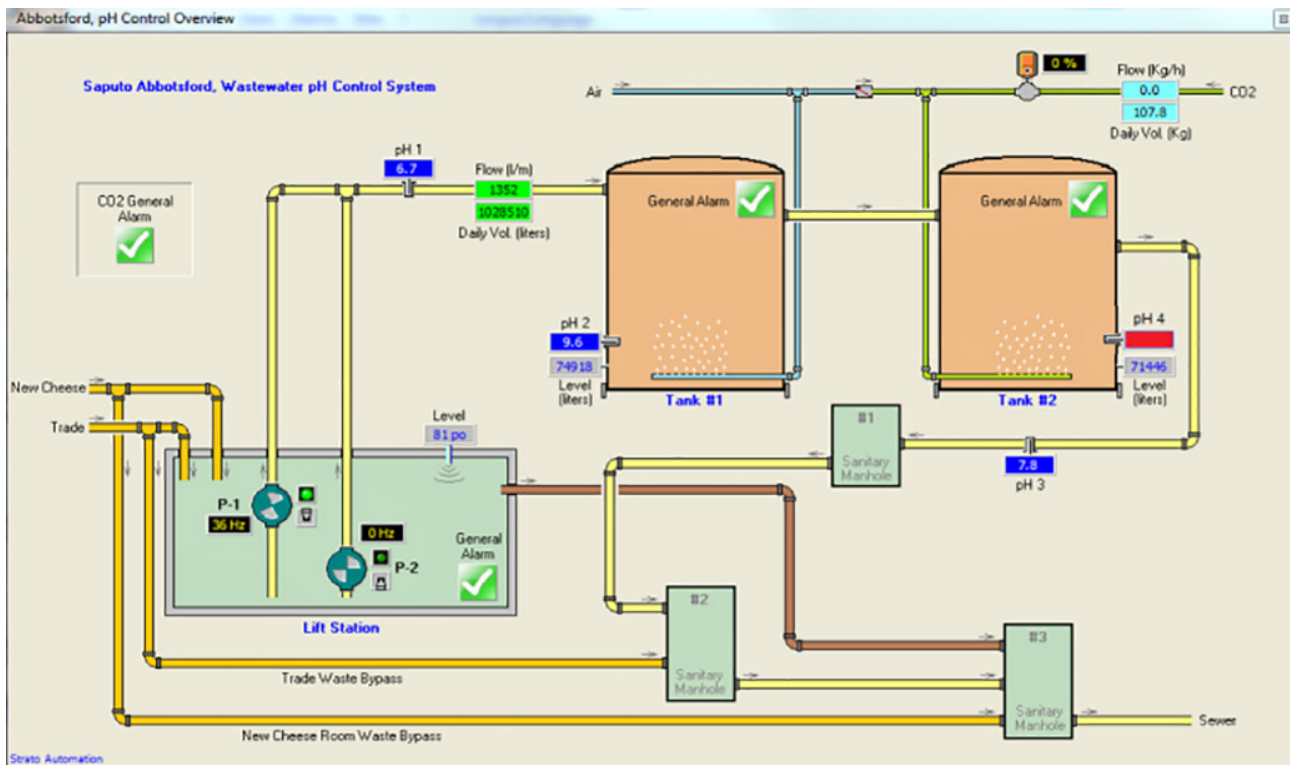

Quality of treated water

- pH value of treated water: 5.5 to 9.5

Technology's benefits / Precautions to follow

- CO₂ is a safe alternative to using strong acids, such as H₂SO₄ and HCl, for pH adjustment.
- Material costs can be marginally higher with CO₂ as the conversion to carbonic acid in water is relatively low: assuming effective carbonic acid conversion from CO₂ is 30%.
- However, overall cost of ownership when considering storage, Health & Safety requirements, such as spill response, is lower.
- The dilution of highly concentrated, stock chemical solutions is also not required for CO₂ pH adjustment systems.

Feedback and other considerations

- Condensed flue gases from the facility's natural gas fired steam boiler are being considered as an alternative to bulk CO₂ deliveries. A key factor requiring more study is the actual percentage of CO₂ that is converted into carbonic acid.
- Other factors for determining the amount of CO₂ required include temperature of the effluent to be mixed with the CO₂ and the delta between incoming pH and permitted limits.

Economic data

- Operating cost: \$0.37 CAD / kg CO₂ (\$0.28 US / kg CO₂)

Case study 2

COMPLEX SYSTEM OF ANAEROBIC FERMENTATION AND BIOMASS BOILER

To make energy and treat waste derived from process, a Japanese dairy plant producing coffee milk, yogurt and liquid diet, decided to install an anaerobic fermentation system and biomass boiler.



Technical characteristics of the technology

- Size of the installations:
 - Diluting and Dissolving Tank: 1 m³
 - Solubilisation Tank: 100 m³
 - Methane Fermentation Tanks (x2): 100 m³ each
- Other parameters:
 - Operating temperature in the fermentation tanks: 55°C
 - Average residence time in the fermentation tanks: 7 days

Type, volume and composition of raw wastewater

- Wastewater and residues resulting from the production of coffee milk, yogurt and liquid diet:
 - Wastewater entering in the aerobic system: 3,000 m³/day
 - Wastewater entering in the anaerobic system: 7 m³/day
 - Coffee residue entering in the biomass boiler: 30 t/day

Parameters	Concentration (mg/L)
COD (anaerobic)	200,000
BOD (aerobic)	800

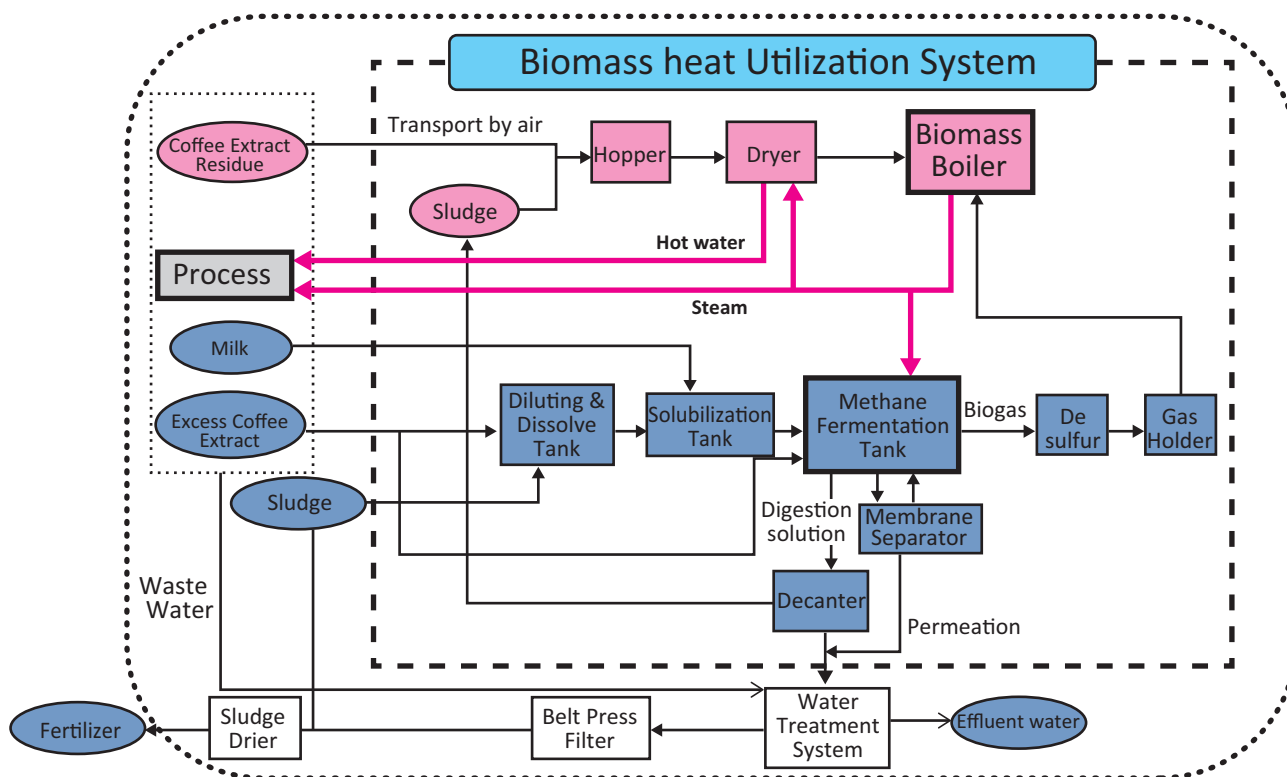

Quality of treated water

Parameters	Concentration (mg/L)
COD (anaerobic)	7.5
BOD (aerobic)	<5
SS	<10
TN	8.6
TP	0.05

Technology’s benefits / Precautions to follow

- Complex system allowing a good treatment
- Production of biogas: 400,000 m³/year
- Biomass boiler helps sludge treatment of aerobic and anaerobic systems.
- Aerobic system improves quality of treated wastewater of anaerobic system.
- Need to keep a constant load in the anaerobic treatment in order to not disturb its operation.

Your feedback about this technology (lessons learned, resolved issues)

- Combination of biomass boiler and anaerobic system appears as a good solution because the treatment of wastewater and residues outside of the site is a costly operation. Moreover, biogas from anaerobic system helps combustion stability of solid fuel in the biomass boiler.

Economic data

- Cost of the system: *¥13 million/month* (cost of equipment and of maintenance) - *\$117,000 US/month*
- Return on investment (based on equipment cost): about 10%
- Solution more economical than waste treatment outside

Case study 3

BIOGAS PRODUCTION ON THE DAIRY PLANT

Due to the high wastewater costs to the municipality, a German dairy plant decided to build its own wastewater treatment plant including a methanation unit. In addition to wastewater treatment, biogas production is guaranteed and energy savings are made.

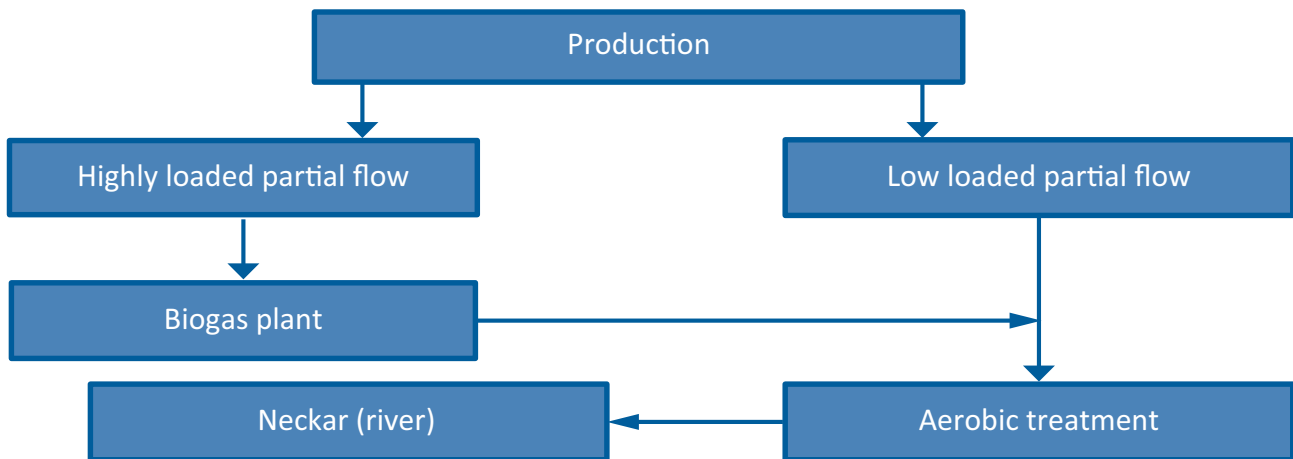

Volume and composition of raw wastewater

- Average flow: 2,000 - 2,500 m³/day

Parameters	Values
Phosphorus	30 mg/L
COD	6200 mg/L
TN	100 mg/L
NH ₄ -N	80 mg/L
NO ₃ -N	20 mg/L

Quality of treated water

Parameters	Values
Phosphorus	1,4 mg/L
COD	42 mg/L (25000kg/y)
TN	3,8 mg/L (2274kg/y)
NH ₄ -N	2,8 mg/L (1663kg/y)
NO ₃ -N	0,75 mg/L (444kg/y)

Technical characteristics of the technology

- Volume of the UASB reactor: 600 m³
- Part of COD degraded in the UASB reactor: about 70%
- Part of COD degraded in the aerobic process: about 30%
- Biogas production:
 - 70% from the UASB reactor
 - 30% from the sludge digestion

Technology's benefits / Precautions to follow

- Biogas production: 150 m³/h (this production satisfies 10% of the steam demand of the dairy plant)
- Energy savings compared to complete aerobic treatment
- Energy-poor process to perform
- Little production of waste sludge
- The aerobic process ensures extensive degradation up to direct discharge quality

Your feedback about this technology (lessons learned, resolved issues)

- The separation between highly burdened wastewater and low-polluted wastewater must be ensured. This is a metrological effort that must work reliably. The use of detergent, with regards to its effects on biology, should be considered.

Economic data

- Installation cost (biogas plant and aerobic treatment): *€6 million (\$6,800,000 US)*
- Running cost: about 4-6% of the installation cost
- Maintenance cost: about 2% of the installation cost
- Return on investment: 3 years

Case study 4

SYNERGY BETWEEN ANAEROBIC AND AEROBIC TREATMENTS

An Italian dairy which produces ricotta cheese in order to resolve issues for disposal of ricotta whey and to produce energy put in place a scheme of effluents treatment in which they use anaerobic technology to treat ricotta whey and other concentrated effluents, followed by aerobic activated sludge step for nitrogen and phosphorus by discharging directly into the river.



We tried to make energy from these

- Type, volume and composition of raw wastes
- Raw wastes: ricotta whey and other concentrated effluents
- Total treated volume: >140 000 m³/year
 - Waste entering in the aerobic system: 210 m³/day
 - Waste entering in the anaerobic system: 170 m³/day

Parameters	Values
COD (anaerobic)	35000 ton/year
COD (aerobic)	235 ton/year
TKN	50 ton/year
TP	19 ton/year
NO ₃ -N	20 mg/L

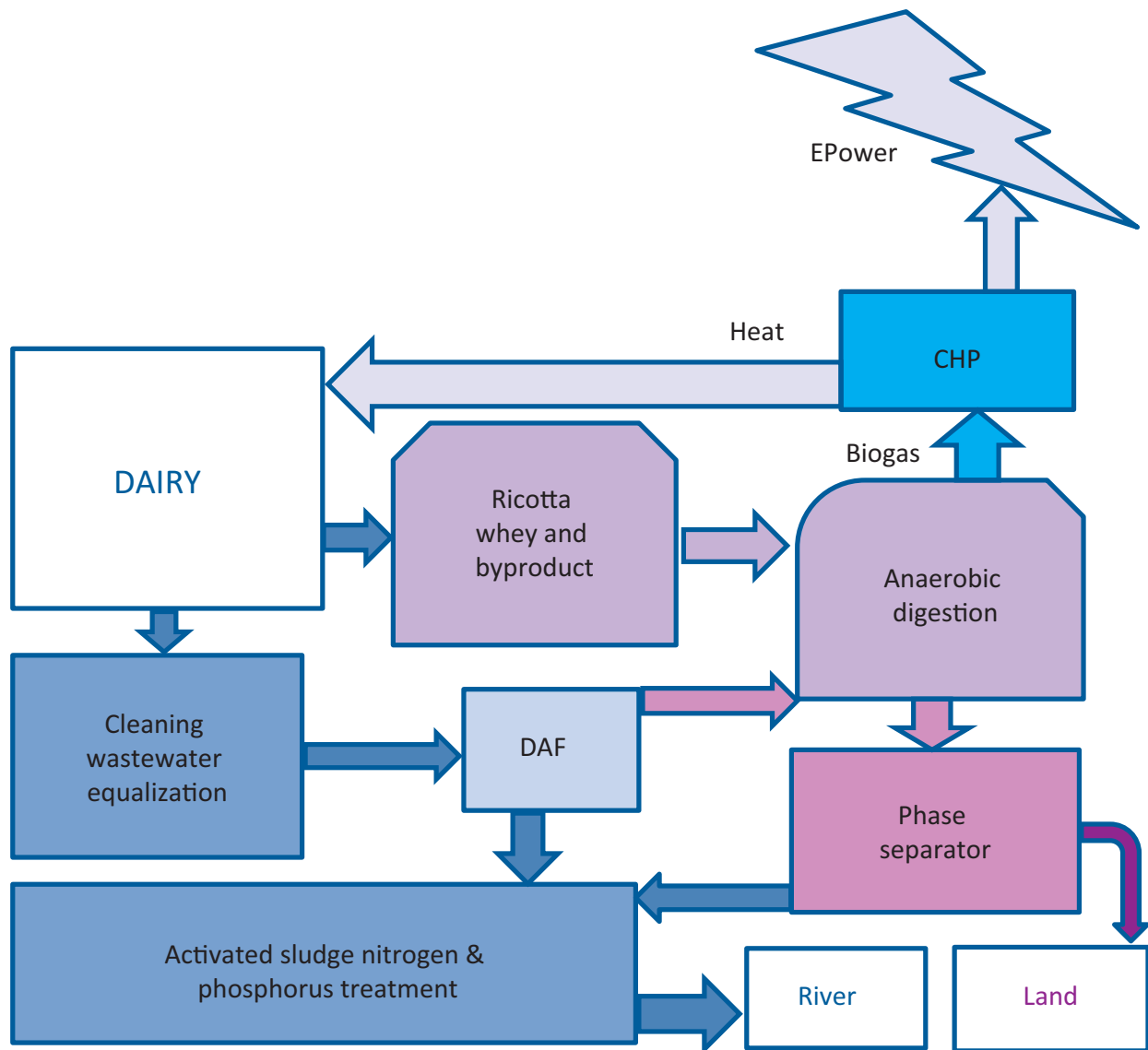

Quality of treated water

(before discharging into the river)

Parameters	Values
COD	<100 mg/L
TKN	<10 mg/L
TP	<8 mg/L

Technical characteristics of the technology

- Size of the installations:
 - Anaerobic digester: 1000 m³
 - Activated sludge plant total volume: 500 m³
- Other parameters:
 - Working time: 365 days/year
 - Power consumption: <340 MWh/year
 - Manpower: 4 hours/day

Technology's benefits / Precautions to follow

- With this system, the dairy saves more than 60% of thermal costs.
 - Produced power: >4150 MWh/year
 - Exchanged heat: >2100 MWh/year
 - Sludge to dispose: 4 ton/day
- Activated sludge wastewater treatment system is more stable by adding nitrogen treatment.
- Some issues on dewatering the sludge due to high volatile content.

Your feedback about this technology (lessons learned, resolved issues)

- The system results are very stable; it is working since 2014 with an average running efficiency of 97%.
- Not more than 2 hours per day operational input required, thanks to a comprehensive control system.
- Total average maintenance man-hours including combined heat and power (CHP) does not exceed 2 hours per day.

Economic data

- Investment cost (CAPEX): *€2.6 million (\$2,950,000 US)*
- Operating cost (OPEX): *€0.1 million/year (\$0.11 US / year)*
- Return on investment: 3.25 years

CASE STUDY 5

BIOGAS PRODUCTION ON THE DAIRY PLANT

Since 2005, a Swedish dairy plant operates its own wastewater treatment plant including a methanation unit. In addition to waste water treatment, biogas production enables good energy savings. Whey (-permeate), biological and flotation sludge from waste water treatment and milk spills as well as waste products (returns from traders) are main contributors to biogas production.

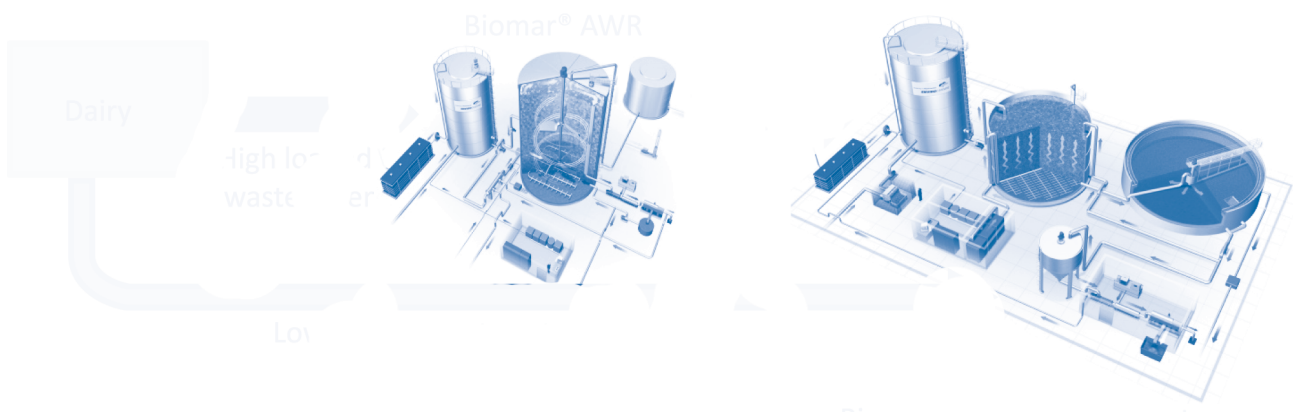

Composition of high loaded wastewater

- Amount: 250 m³/day

Parameters	Values
COD	100,000 mg/L
COD load	25 t/day
TN	1,900 mg/L
TP	2,400 mg/L

Composition of low loaded wastewater

- Amount: 1.500 m³/day

Parameters	Values
COD	1,500 mg/L
COD load	2.25 t/day
TN	150 mg/L
TP	70 mg/L



Biomar® wastewater treatment plant with 2 Biomar AWR-reactors (right) and a Biomar OSB-reactor (left)

Technical characteristics of the technology

- Biomar® AWR (anaerobic process) up to 90% of COD load reduction
- Nitrification and denitrification, aerobic process for discharge to municipal sewage system
- 10,000 m³ biogas production daily from sludge digestion (natural gas equivalent: 6,500 m³/day)
- Phosphorus elimination down to less than 1,5 mg/L
- Operation more than 10 years

Technology's benefits / Precautions to follow

- Energy savings compared to complete aerobic treatment
- Low sludge production
- Low treatment chemicals demand
- Low electricity demand
- Lower operation cost
- Less sludge discharge cost
- Less area consumption compared to complete aerobic treatment

CASE STUDY 6

BIOGAS PRODUCTION ON THE DAIRY PLANT

With a large production increase planned, the existing aerobic wastewater treatment plant in an Irish dairy needed to be upgraded to maintain high effluent quality for a discharge to local watercourse. The company decided to install another treatment solution to extend the existing plant and to produce biogas.



NVP Energy module and container

Composition of raw wastewater

Parameters	Values
COD	500 - 5000 mg/L
TSS	<1000 mg/L

Quality of treated water

Parameters	Values
COD	90% removal rate
TSS	50% removal rate

Technical characteristics of the technology

- Treatment composed of:
 - A dissolved air flotation
 - One NVP Energy module
 - An anoxic tank
- Treatment capacity: 500 m³ of wastewater/day/module
- Module dimensions:
 - 12m (height)
 - 4.5m (diameter)

Technology's benefits / Precautions to follow

- 90% organic sludge removed
- >85% methane content biogas; 100% available for use
- Biogas production satisfying the heat needs of the production facility
- Closes carbon loop, displaces fossil fuels
- No heating or aeration required; passive pumped system
- Small footprint on site
- Smart controls system with remote monitoring
- Ideal solution for:
 - Retrofit
 - Expansion
 - New build

Your feedback about this technology (lessons learned, resolved issues)

- The treatment solution achieves 90% COD reduction and 50% TSS removal.
- The dairy plant elutes increased volumes of wastewater within their discharge permitted limits with 50% less operating costs compared to the previous aerobic installation.
- Sludge production has been reduced by 90%.

Economic data

- Return on investment: average 3 years

CASE STUDY 7

USE OF ANAEROBIC AND AEROBIC REACTORS TO TREAT DAIRY WASTEWATER

Case study based from the publication of Saxena S. and Choudhary M.P. (ref [23])

To treat wastewater and to comply with national and local regulations regarding water discharge, Saras Dairy Jaipur has created a complete treatment channel mainly composed of anaerobic and aerobic technologies.

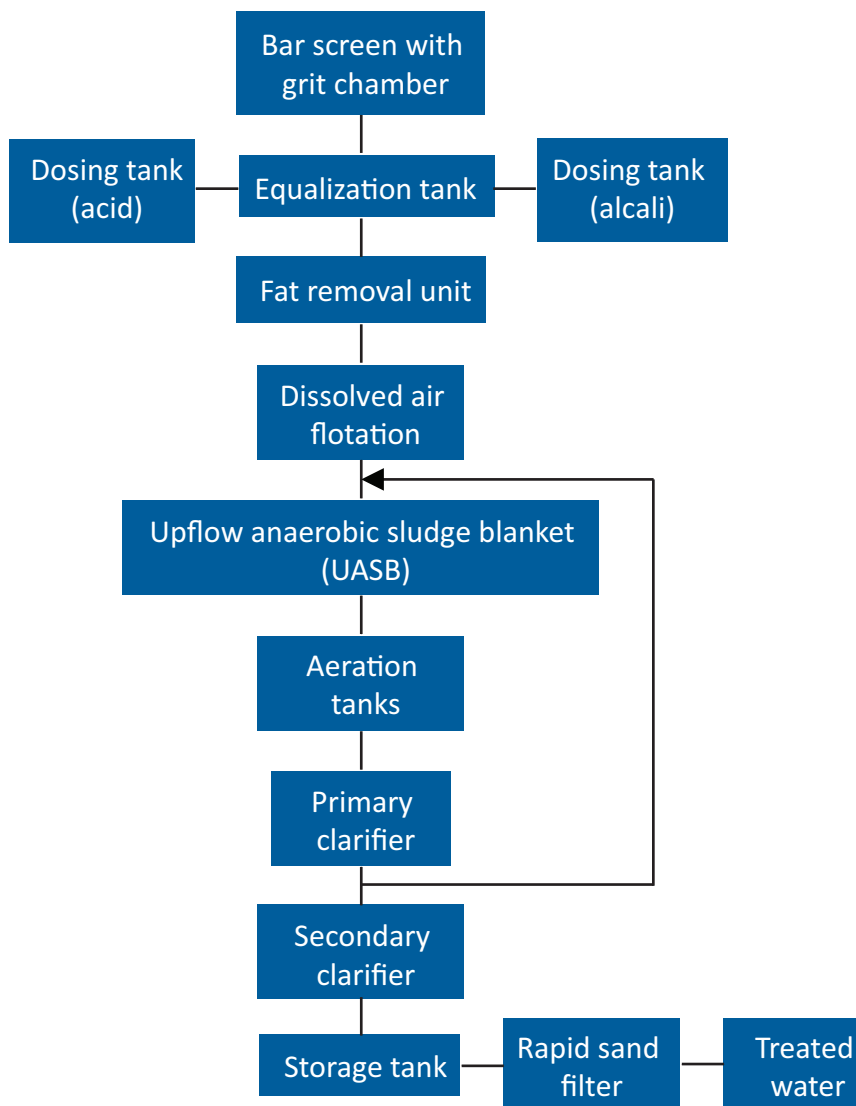

Type, volume and composition of raw wastewater

- Raw wastewater: mainly cleaning waters
(Domestic wastewater is discharged in the public sewerage)
- Average flow: 800 m³/day

Parameters	Concentration (mg/L)
BOD	1477
COD	4800
TDS	2214
TSS	1203
DO	0.5
Oil and Grease	63
Total alkalinity	847
Total hardness	510
Kjeldahl nitrogen	100
pH	6.20

Quality of treated water

Parameters	Concentration (mg/L)
BOD	12
COD	32
TDS	1035
TSS	7
DO	9
Oil and Grease	2.5
Total alkalinity	290
Total hardness	75
Kjeldahl nitrogen	8
pH	7.60

Technical characteristics of the technology

- Surface area occupied by the treatment plant: approximately 25,000 m²
- Volume of aerobic reactors: approximately 4,000 m²
- Volume of anaerobic reactors approximately 2,000 m³

Technology's benefits / Precautions to follow

- Treatment channel allows the dairy to comply with national and local regulations. All water quality limits are respected except pH which exceeds of 0.1.
- Considering its quality, treated water can be used for gardening and floor washing purposes or it can also be drained into the sewage system.
- Sludge from the treatment plant is dried and used as manure in the garden areas of the plant premises itself. If there is any additional sludge, it is sold out in the market.

CASE STUDY 8

MEMBRANE BIOREACTOR FOR WASTEWATER FROM ICE CREAM PLANT

To treat wastewater from one of these plants specialised in the ice cream production, a Japanese company decided to install a membrane bioreactor (MBR). This technology was chosen to replace an old activated sludge treatment.



Membrane tank

Type, volume and composition of raw wastewater

- Raw wastewater: mainly cleaning waters
- (Domestic wastewater is discharged in the public sewerage)
- Average flow: 1,000 m³/day

Parameters	Concentration (mg/L)
BOD	763
SS	421
n-Hexane	30

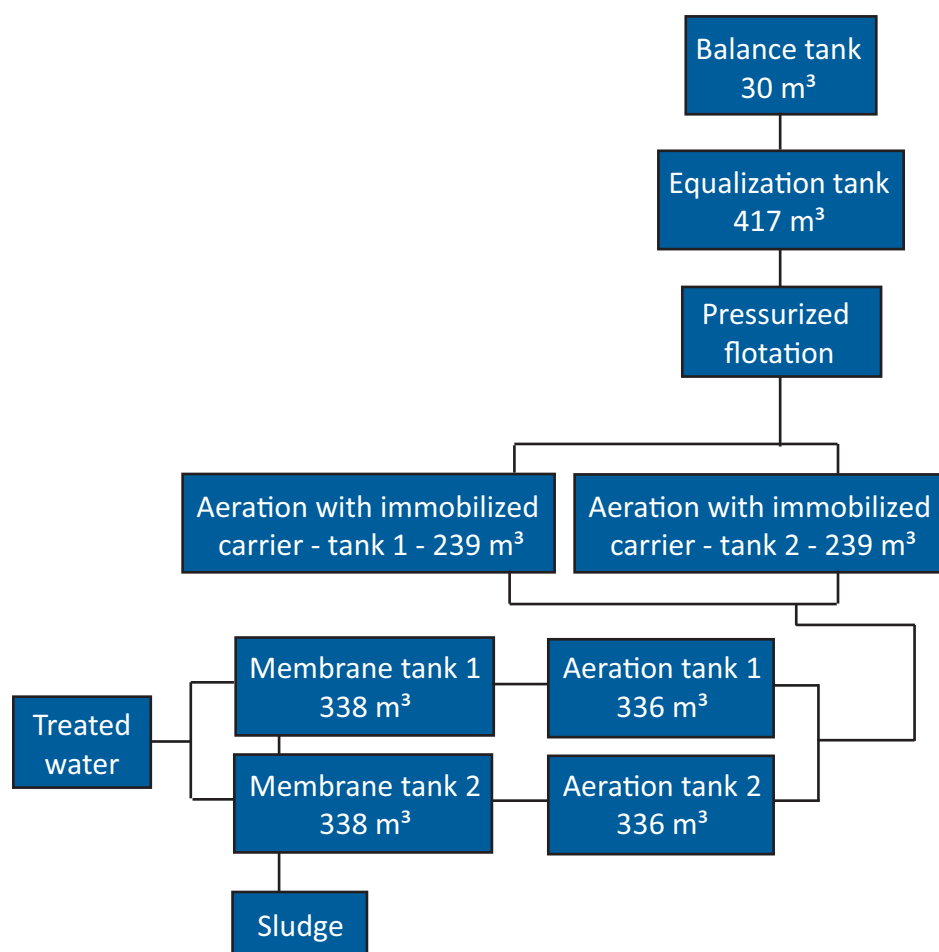

Quality of treated water

Parameters	Concentration (mg/L)
BOD	0.8
SS	<1
TN	1.8
TP	0.7
n-Hexane	<0.5

Technical characteristics of the technology

- Designed amount of wastewater: 1,400 m³/day
- Membrane tank with microfiltration membranes
- Total area of membrane: 3,480 m²
- MLSS: 4,000 mg/L

Technology's benefits / Precautions to follow

- Technology allowing a better treatment of wastewater than with a conventional activated sludge

Parameters	Treated water	
	Concentration (mg/L) in 2011 (before the installation of the system)	Current concentration (mg/L)
BOD	5.3	0.8
SS	7	<1
TN	2.6	1.8

Excess sludge volume reduction: 50%

- If wastewater contains fats, installation of a primary treatment like flotation is recommended in order to avoid membrane clogging

Your feedback about this technology (lessons learned, resolved issues)

- The membrane bioreactor is easier to control than conventional channel like activated sludge. Moreover, sludge separation from water is also helped along with minimising the risk of sludge discharge with the treated waste, except in the case of a membrane leak.

Economic data

- Installation cost (membranes and membrane tanks): ¥160 million (\$1,440,000 US)
- Running cost (mainly electricity and maintenance): ¥25/m³ of wastewater (\$0.22 US/m³)

CASE STUDY 9

MEMBRANE BIOREACTOR FOR WASTEWATER FROM LIQUID DIET PLANT

A Japanese company decided to install a membrane bioreactor (MBR) on one of its plants specialised in the production of liquid diet in order to avoid poor sludge activity and a degradation of effluent quality that may be caused by the wastewater load fluctuation. In addition to its treatment effectiveness, this technology also allows energy savings and reduction of excess sludge.



Membrane tank

Type, volume and composition of raw wastewater

- Raw wastewater: mainly cleaning waters
- (Domestic wastewater is discharged in the public sewerage)
- Average flow: 800 m³/day

Parameters	Concentration (mg/L)
BOD	359
SS	216

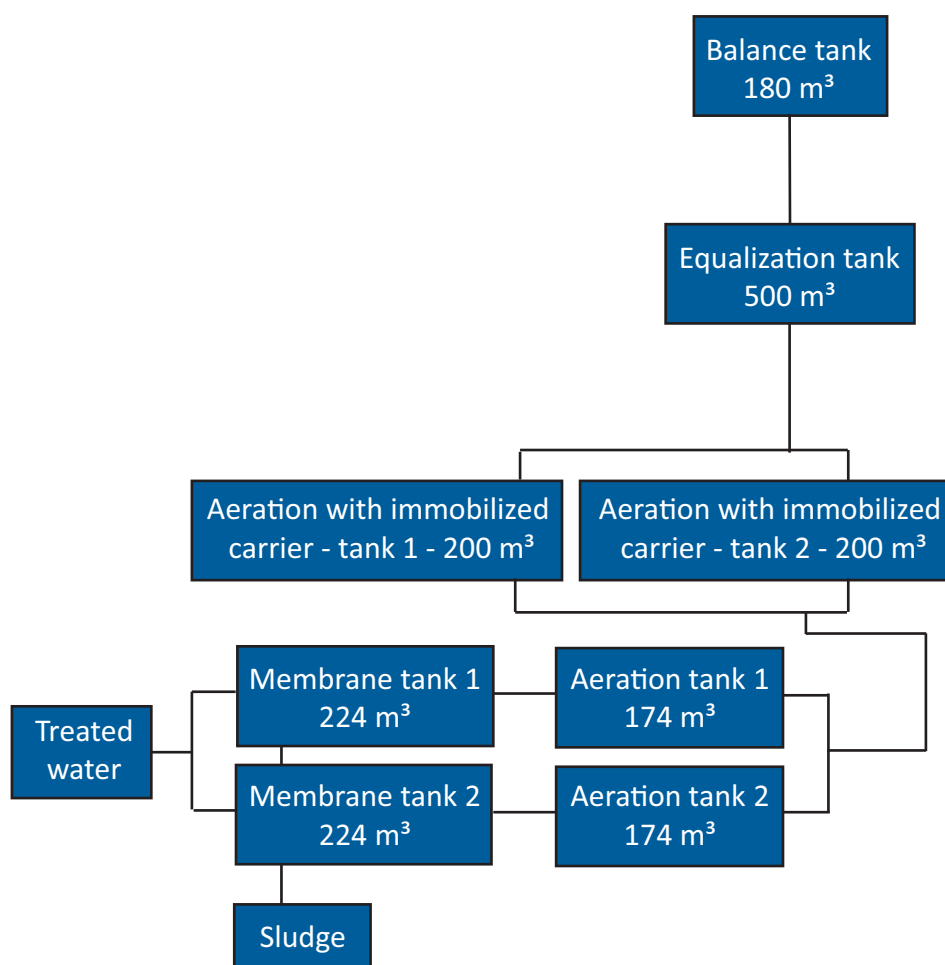

Quality of treated water

Parameters	Concentration (mg/L)
BOD	<1
SS	0
n-Hexane	<1
TN	30.2
TP	7.33

Technical characteristics of the technology

- Designed amount of wastewater: 1,600 m³/day
- Membrane tank with microfiltration membranes
- Total area of membrane: 4,640 m²
- MLSS: 3,000 mg/L

Technology's benefits / Precautions to follow

- In comparison with the activated sludge system used before, the membrane bioreactor allows a reduction of:
 - 25% for the electricity bill
 - 50% for the volume of excess sludge

- If wastewater contains fats, installation of a primary treatment like flotation is recommended in order to avoid membranes clogging

Your feedback about this technology (lessons learned, resolved issues)

- Membrane bioreactor is a wastewater treatment which is easier to control than conventional channel like activated sludge. Moreover, it contributes to energy savings and waste reduction.

Economic data

- Installation cost (membranes, membrane tanks and aeration tanks): *¥300 million (\$2,690,000 US)*
- Running cost (mainly electricity and maintenance): *¥25/m³ of wastewater (\$0.22 US/m³)*. This cost reached *¥50/m³ of wastewater (\$0.45 US/m³)* with the previous treatment. Therefore, it has been divided by 2 with the installation of this system
- Return on investment: about 5%

CASE STUDY 10

MEMBRANE BIOREACTOR FOR WASTEWATER FROM DAIRY PLANT

Due to its expansion, a Japanese dairy plant producing cream, milk and skim milk powder decided to change its wastewater treatment. To maintain a good effluent quality, it replaced its sedimentation system by a membrane filtration system positioned just after two lagoons used for the degradation of organic matter.



Lagoons for aeration

Type, volume and composition of raw wastewater

- Raw wastewater: mainly cleaning waters
- (Domestic wastewater is discharged in the public sewerage)
- Average flow: 1,450 m³/day

Parameters	Concentration (mg/L)
COD	≈ 1,000
BOD	850



New membrane tank

Quality of treated water

Parameters	Concentration (mg/L)
COD	6.8

Technical characteristics of the technology

- Designed amount of wastewater: 1,500 m³/day
- Membrane tank with microfiltration membranes
- Total area of membrane: 4,640 m²
- MLSS: 7,000 mg/L

Technology's benefits / Precautions to follow

- A treatment plant with a membrane bioreactor has an operation helped along and is more reliable. Moreover, sludge control is easier than a precipitation system (system used to control sludge health)
- Need to control MLSS effects on sludge viscosity because a high concentration can create membrane clogging. Thus, MLSS was reduced by 3 g/L (10 g/l to 7 g/L) in order to improve the operation of the plant.

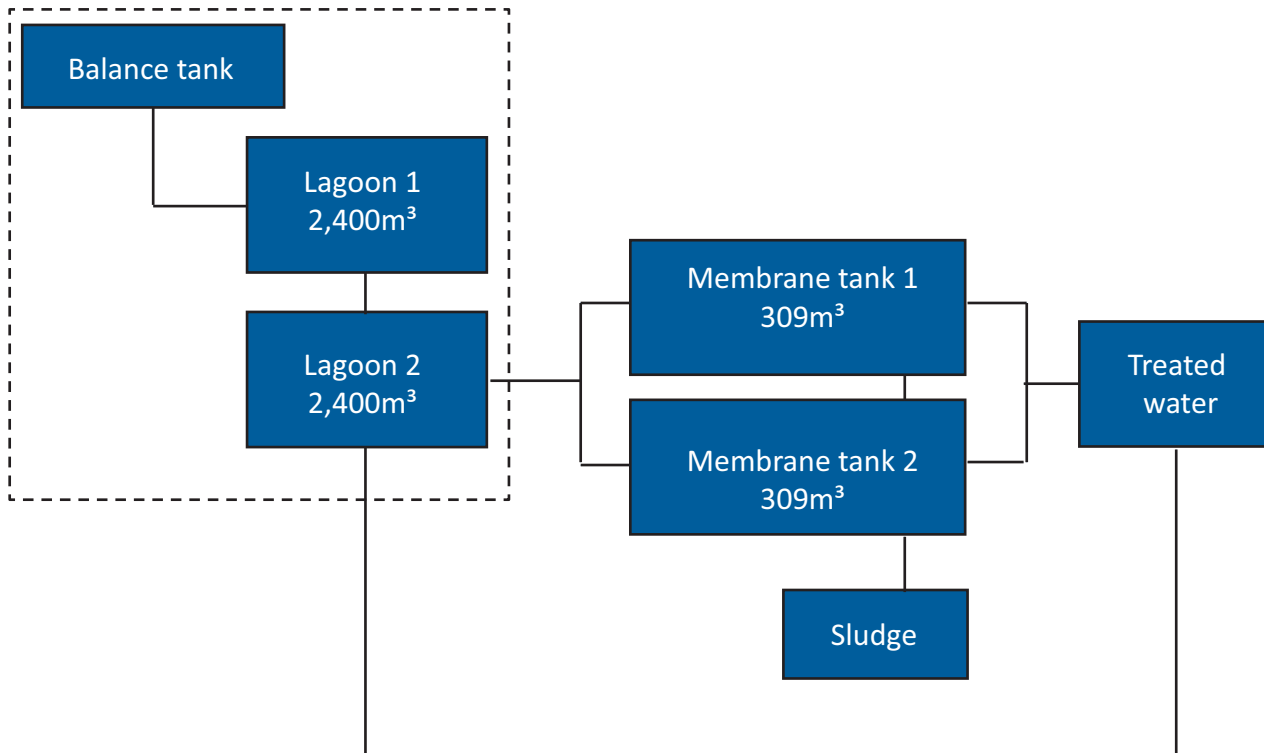

Technology's benefits / Precautions to follow

- A treatment plant with a membrane bioreactor has an operation helped along and is more reliable. Moreover, sludge control is easier than a precipitation system (system used to control sludge health)
- Need to control MLSS effects on sludge viscosity because a high concentration can create membrane clogging. Thus, MLSS was reduced by 3 g/L (10 g/l to 7 g/L) in order to improve the operation of the plant.

Your feedback about this technology (lessons learned, resolved issues)

- Adding membrane bioreactor to an existing system is one of the easiest solutions to increase amount of wastewater to treat and to improve quality of treated wastewater.

Economic data

- Installation cost (membranes and membrane tanks): ¥190 million (\$1,700,000 US)
- Running cost (mainly electricity and maintenance): ¥25/m³ of wastewater (\$0.22 US/m³)

CASE STUDY 11

ULTRAFILTRATION AT THE OUTLET OF LAGOON PLANT

In order to comply with regulations, a French cheese manufacture decided to install ultrafiltration units at the outlet of its lagoon plant.



Type, volume and composition of raw wastewater

- Wastewater entering in the treatment plant is of three kinds:
 - white waters (waters generated at the beginning and the end of a production cycle),
 - cleaning waters (waters containing acid and alkaline solutions) and
 - domestic wastewater (waters from premises used by the staff)
- Average flow of wastewater is around 150m³/day.

Parameters (mg/L)	Entrance to lagoon plant	Entrance to ultrafiltration units
COD	2000	50 - 100
BOD5	1000	ND
TSS	700 - 800	+100
TKN	50	ND
Oxydised nitrogen (NO ₂ - NO ₃)	20	ND
TP	10	ND

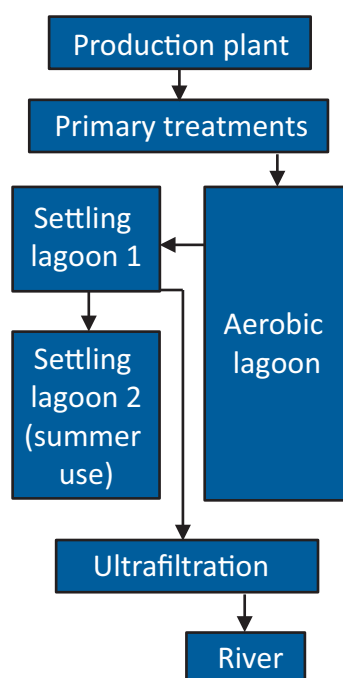

Quality of treated water

Parameters (mg/L)	Outlet of the ultrafiltration units	Discharge standards
COD	20 - 30	50
BOD5	5	ND
TSS	<10	20
TKN	4	ND
Oxydised nitrogen (NO ₂ - NO ₃)	3	ND
TP	1 (thanks to FeCl ₃)	ND

Technical characteristics of the technology

- Three ultrafiltration units are installed in the wastewater treatment plant.
- One ultrafiltration unit is composed of several plates, each of which contains an organic flat membrane.

Technology's benefits / Precautions to follow

Benefits	Precautions to follow and limits
Quality of the discharged water in relation to the regulations	Occasional clogging of the membranes due to biofilms. It has as a consequence a higher cleaning frequency (each unit is cleaned every 2 to 5 days during 2 hours).
Less investment required compared ng of a new treatment plant to reach the same objectives	Cost for the replacement of the membranes (all the membranes of the same unit are replaced every 4 to 5 years).

Economic data

Type of costs	Sum (€) / Sum (\$US)
Total cost of the installation (building with the three ultrafiltration units, pumps)	€700k / \$810k US
Cost of the cleaning products for the membranes	€1k - 2k/y / \$1k - 2,5k US/y
Cost for the replacement of the membranes	≈ €25k/y / ≈ \$29k US/y

- There is also an operating cost because the monitoring of this treatment plant requires the presence of one person during 2 hours per day (without counting time for analyses).

5

CONCLUSIONS

All existing and future technologies to treat dairy wastewater should not let the dairy processors forget that the best way to tackle the water pollution issue is to reduce milk and by-product losses during processing. Indeed, the organic load of effluent should also be reduced at the source by preventing product residues from entering the effluent stream. The main recommendation to prevent wastewater stream contamination is to separate and valorise the first minute's rinsing water which represents 90% of the total organic load.

Several innovative combinations of technologies have been identified and new studies on the application of lab-scale treatments at pilot or industrial scale will provide solutions for the dairy industry and help face the huge challenges in this field which include the conceptualisation that dairy effluent is no longer waste water but a resource water. Indeed, when appropriate treatments are applied, these effluents are sources of high-quality water, feed, fertilizer and/or energy production.

6

REFERENCES

- [1] JRC, European IPPC Bureau, (October 2018). Best Available Techniques (BAT) Reference Document in the Food, Drink and Milk Industries - final draft. 796p.
- [2] KUSHWAHA, J.P., SRIVASTAVA, V.C., MALL, I.D., (2011). An Overview of Various Technologies for the Treatment of Dairy Wastewaters. *Critical Reviews in Food Science and Nutrition*, 51(5), 442-452
- [3] KOLEV SLAVOV, A., (2017). General Characteristics and Treatment Possibilities of Dairy Wastewater - A Review. *Food Technology and Biotechnology*, 55(1), 14-28
- [4] CASTILLO DE CAMPINS, S., (2005). Etude d'un procédé compact de traitement biologique aérobie d'effluents laitiers. Thèse en Sciences Ecologiques, Vétérinaires, Agronomiques et Bioingénieries : Microbiologie et Biocatalyse industrielles. Institut National des Sciences Appliquées, Toulouse, 198p.
- [5] KARTHIKEYAN, V., VENKATESH, K.R., ARUTCHELVAN, V., (2015). A Correlation Study on Physico-Chemical Characteristics of Dairy Wastewater. *International Journal of Engineering Science and Technology*, 7(2), 89-92
- [6] BIRWAL, P., DESHMUK, G.P., SAURABH, S.P., (2017). Advanced Technologies for Dairy Effluent Treatment. *Journal of Food, Nutrition and Population Health*, 1(1), 5p.
- [7] DABROWSKI, W., (2011). Effectiveness of constructed wetlands for dairy wastewater treatment. *Ecological Chemistry and Engineering*, 18(2), 175-181
- [8] ZHANG, J.B., 2011. Procédé de traitement anaérobie des boues et de valorisation du biogaz. Thèse en Génie des Procédés et des Produits. Institut National Polytechnique de Lorraine, 221p.
- [9] MASSARA, T.M., KOMESLI, O.T., SOZUDOGRU, O., KOMESLI, S., KATSOU, E., (2017). A Mini Review of the Techno-environmental Sustainability of Biological Processes for the Treatment of High Organic Content Industrial Wastewater Streams. *Waste Biomass Valor*, 8, 1665-1678
- [10] FRAGA, F.A., GARCÍA, H.A., HOOIJMANS, C.M., MÍGUEZ, D., BRDJANOVIC, D., (2017). Evaluation of a membrane bioreactor on dairy wastewater treatment and reuse in Uruguay. *International Biodeterioration & Biodegradation*, 119, 552-564

- [11] ANDRADE, L.H., MENDES, F.D.S., ESPINDOLA, J.C., AMARAL, M.C.S., (2014). Nanofiltration as tertiary treatment for the reuse of dairy wastewater treated by membrane bioreactor. *Separation and Purification Technology*, 126, 21-29
- [12] ERKAN, H.S., GUNALP, G., ENGIN, G.O., (2018). Application of submerged membrane bioreactor technology for the treatment of high strength dairy wastewater. *Brazilian Journal of Chemical Engineering*, 35(1), 91-100
- [13] ANDRADE, L.H., MENDES, F.D.S., ESPINDOLA, J.C., AMARAL, M.C.S., (2015). Reuse of dairy wastewater treated by membrane bioreactor and nanofiltration: technical and economic feasibility. *Brazilian Journal of Chemical Engineering*, 32(3), 735-747
- [14] SANGUANSRI, P., MUSTER, T., SELLAHEWA, J. (eds) (2014). *Water Treatment Pilot Plant Evaluation at a Dairy Manufacturing Site*. Australian Water Recycling Centre of Excellence, Brisbane, Australia. 61p.
- [15] BORTOLUZZI, A.C., FAITÃO, J.A., LUCCIO, M.D., DALLAGO, R.M., STEFFENS, J., ZABOT, G.L., TRES, M.V., (2017). Dairy wastewater treatment using integrated membrane systems. *Journal of Environmental Chemical Engineering*, 5, 4819-4827
- [16] ZIELINSKA, M., GALIK, M., (2017). Use of Ceramic Membranes in a Membrane Filtration Supported by Coagulation for the Treatment of Dairy Wastewater. *Water, Air & Soil Pollution*, 228(173)
- [17] SANT'ANNA, V., MARCZAK, L.D.F., & TESSARO, I.C. (2012). Membrane concentration of liquid foods by forward osmosis: process and quality view. *Journal of Food Engineering*, 111(3), 483-489
- [18] CATH, T.Y., CHILDRESS, A.E., ELIMELECH, M. (2006). Forward osmosis: principles, applications, and recent developments. *Journal of Membrane Science*, 281(1-2), 70-87
- [19] CHEKLI, L., PHUNTSO, S., SHON, H.K., VIGNESWARAN, S., KANDASAMY, J., & CHANAN, A. (2012). A review of draw solutes in forward osmosis process and their use in modern applications. *Desalination and Water Treatment*, 43(1-3), 167-184
- [20] MCCUTCHEON, J.R., MCGINNIS, R.L., & ELIMELECH, M. (2005). A novel ammonia—carbon dioxide forward (direct) osmosis desalination process. *Desalination*, 174(1), 1-11
- [21] MCGINNIS, R.L., HANCOCK, N.T., NOWOSIELSKI-SLEPOWRON, M.S., & MCGURGAN, G.D. (2013). Pilot demonstration of the NH₃/CO₂ forward osmosis desalination process on high salinity brines. *Desalination*, 312, 67-74
- [22] CHEN, L., GU, Y., CAO, C., ZHANG, J., NG, J.W., & TANG, C. (2014). Performance of a submerged anaerobic membrane bioreactor with forward osmosis membrane for low-strength wastewater treatment. *Water Research*, 50, 114-123
- [23] SAXENA, S., CHOUDHARY, M.P. (2017). Performance Evaluation of Dairy Wastewater Treatment Plant. *International Research Journal of Engineering and Technology*, 4(11), 1287-1291

International Dairy Federation

INSTRUCTIONS TO AUTHORS

Submission of papers

Submission of a manuscript (whether in the framework of an IDF subject on the programme of work or an IDF event) implies that it is not being considered contemporaneously for publication elsewhere. Submission of a multi-authored paper implies the consent of all authors.

Types of contribution

Monographs; separate chapters of monographs; review articles; technical and or scientific papers presented at IDF events; communications; reports on subjects on the IDF programme of work.

Language

All papers should be written in English.

Manuscripts

- Files to be sent electronically by e-mail or via our FTP site. Login details will be sent upon request.
- Final document in Word 2003 or 2007
- All tables/figures included in final document to be sent also in separate Word, Excel or PowerPoint files, in black-and-white or colour format.
- All files to be named with author's surname plus title of paper/tables/figures.

References

- References in the document to be numbered and placed between square brackets.
- Reference lists at the end of the document to contain the following:
 - Names and initials of all authors;
 - Title of paper (or chapter, if the publication is a book);
 - If the publication is a journal, title of journal (abbreviated according to 'Bibliographic Guide for Editors and Authors', published by The American Chemical Society, Washington, DC), and volume number;
 - If the publication is a book, names of the publishers, city or town, and the names and initials of the editors;
 - If the publication is a thesis, name of the university and city or town;
 - Page number or number of pages, and date.

Example: 1 Singh, H. & Creamer, L.K. Aggregation & dissociation of milk protein complexes in heated reconstituted skim milks. *J. Food Sci.* 56:238-246 (1991).

Example: 2 Walstra, P. The role of proteins in the stabilization of emulsions. In: G.O. Phillips, D.J. Wedlock & P.A. William (Editors), *Gums & Stabilizers in the Food Industry* - 4. IRL Press, Oxford (1988).

Abstracts

An abstract not exceeding 150 words must be provided for each paper/chapter to be published..

Address

Authors & co-authors must indicate their full address (including e-mail address).

Conventions on spelling and editing

IDF's conventions on spelling and editing should be observed. See Annex 1.

ANNEX 1

IDF CONVENTIONS ON SPELLING AND EDITING

In the case of native English speakers the author's national conventions (British, American etc.) are respected for spelling, grammar etc. but errors will be corrected and explanation given where confusion might arise, for example, in the case of units with differing values (gallon) or words with significantly different meanings (billion).

"	Usually double quotes and not single quotes
? !	Half-space before and after question marks, and exclamation marks
±	Half-space before and after
microorganisms	Without a hyphen
Infra-red	With a hyphen
et al.	Not underlined nor italic
e.g., i.e.,...	Spelled out in English - for example, that is
litre	Not liter unless the author is American
ml, mg,...	Space between number and ml, mg,...
skimmilk	One word if adjective, two words if substantive
sulfuric, sulfite, sulfate	Not sulphuric, sulphite, sulphate (as agreed by IUPAC)
AOAC <u>INTERNATIONAL</u>	Not AOAC!
<u>programme</u>	Not program unless a) author is American or b) computer program
milk and milk product	rather than "milk and dairy product" - Normally some latitude can be allowed in non scientific texts
-ize, -ization	Not -ise, -isation with a few exceptions
Decimal comma	in Standards (only) in both languages (as agreed by ISO)
No space between figure and % - i.e. 6%, etc.	
Milkfat	One word
USA, UK, GB	No stops
Figure	To be written out in full
1000-9000	No comma
10 000, etc.	No comma, but space
hours	∅ h
second	∅ s
litre	∅ l
the Netherlands	
Where two or more authors are involved with a text, both names are given on one line, followed by their affiliations, as footnotes	
for example	A.A. Uthar ¹ & B. Prof ² ¹ University of ² Danish Dairy Board

IDF does not spell out international organizations

INTERNATIONAL DAIRY FEDERATION / FEDERATION INTERNATIONALE DU LAIT
Boulevard Auguste Reyers, 70/B - 1030 Brussels (Belgium) - <http://www.fil-idf.org>